



VILLAGE WROUGHT IRON

Wrought Ironwork Manufacturing

All products are made in Central New York, using only high-quality, lead free, domestic materials.



VOLUME 49, ISSUE NO. 5

The Timeless Trade of Ironworking

Family owned and operated wholesale supplier for over 45 years, Village Wrought Iron, Inc. carries an extensive line of products including giftware, lawn & garden designs, candleware and interior accessories. All are guaranteed to add charm and beauty to your home & yard.

We are committed to making sure your needs are met through great customer service, product quality and fast shipping times. All products are made in Central New York, using only high-quality, lead free, domestic materials. We dropship directly to your customer or distribute our wholesale products to your brick & mortar store/warehouse.



Made in the USA

CONTENTS

PAGE	TITLE	PAGE	TITLE
1	Cover	60	Plant Hangers - Square Iron
2	Introduction	61	Plaques - A-Z -Over The Door
3	Table of Contents	62	Plaques - Over The Door
4	Bookends	63	Recycle Bins & Magazine Stands
5	Candleware - Pillar candle Holder - Fireplace	64	S - Hooks
6	Candleware – Pillar Candle Holder – Table Top	65	S - Hooks
7	Candleware – Pillar Candle Holder – Table Top	66	S - Chains
8	Collar & Leash Holder - Dog & Cat	67	S - Hooks Decorative
9	Collar & Leash Holder - Dog & Cat	68	Shelf Brackets
10	Cat & Dog - Key Holders	69	Shelf Brackets
11	Cat & Dog - Key Holders	70	Shelf Brackets - Extra Heavy
12	Cat & Dog - Wall Hooks	71	Shelf Brackets - Extra Heavy
13	Cat & Dog - Welcome Signs	72	Sign Brackets
14	Coat Bars – CUSTOM	73	Sign Brackets
15	Coat Bars – Decorative	74	Silhouettes - Hanging
16	Cup Racks	75	Silhouettes - Hanging
17	Curtain - Cranes	76	School FUNDRAISING—NEW
18	Curtain - Rods	77	Snow Gauges
19	Curtain - Brackets Included with OUR Curtain Rods	78	Sports - Men - Key Holders
20	Curtain - Brackets For OUR Curtain 1/2 In. Rods	79	Sports - Men - Wall Hooks
21	Curtain - Rings For OUR Curtain Rods	80	Sports - Women - Wall Hooks
22	Curtain - Shelf Brackets Fits OUR 1/2 In. Rods	81	The Outhouse - Home Decor
23	Curtain - Shelf Brackets Fits OUR 1/2 In. Rods	82	Toilet Tissue Holders -Roller Style
24	Curtain - Tie Backs	83	Toilet Tissue Holders - Traditional
25	Curtain - Tie Backs	84	Towel Bars
26	Electrical - Switch & Outlet Covers	85	Towel Holders - Ring Style
27	Electrical - Switch & Outlet Covers	86	Trellises - Natural to Rusted Tripod
28	Electrical - Understand Our Codes	87	Triangle Dinner Chimes
29	Electrical - Switch & Outlet Covers - CUSTOM	88	Wall Hooks - DOUBLE HOOK
30	Garden - Hose Holders & Guides	89	Wall Hooks - EXTRA SMALL
31	Garden - Stakes – Trellises - Natural to Rusted Tripod	90	Wall Hooks - LARGE
32	Garden - Stakes – Natural To Rusted	91	Wall Hooks - Miscellaneous
33	Garden - Stakes – Natural To Rusted	92	Wall Hooks - Narrow & Wide Primitive
34	Hair Care Caddy	93	Wall Hooks - SMALL A-Z
35	Hair Care Caddy	94	Wall Hooks - SMALL Animals
36	Hardware – Cabinet Door Handles & Knobs	95	Wall Hooks - SMALL Animals
37	Hardware – Cabinet Door Handles & Knobs	96	Wall Hooks - SMALL Equipment
38	House Letters & Numbers	97	Wall Hooks - SMALL
39	House Letters & Numbers	98	Wall Hooks - SMALL - Magnetic
40	House Plaques – CUSTOM	99	Wall Hooks - SMALL Men
41	House Plaques – CUSTOM	100	Wall Hooks - SMALL Motorized Vehicles
42	Key Chains	101	Wall Hooks - SMALL Women
43	Key Holders	102	Welcome Signs - SMALL & LARGE
44	Key Holders	103	Welcome Signs - SMALL & LARGE
45	Key Holders	104	Welcome Signs - MEDIUM
46	Key Holders - Cats & Dogs	105	Welcome Signs - MEDIUM
47	Key Holders - Sports	106	Wine - Rack & 2 Glass Caddy
48	Mantle Hooks	107	Wine - Rack & 4 Glass Caddy
49	Mitten & Boot Drying Stands	108	Wine - Rack & Stands
50	Napkin Holders	109	Wine - Rack & Stands
51	Napkin Holders	110	Wine - Racks - Wall Mount
52	Napkin Rings	111	Wine - Racks - Wall Mount
53	Organize	112	Wood Racks
54	Paper Towel Holders - Wall Mount	113	Wood Racks
55	Paper Towel Holders - Wall Mount	114	Wreath Hangers
56	Paper Towel Holders - Counter Top	115	Wreath Hangers
57	Recipe Card Holder	116	Terms & Conditions
58	Plant Hangers - Flat Iron	117	Back Cover
59	Plant Hangers - Removable		

BOOKENDS

Measure 5" W. x 6 ¼" H. x 3 ½" D.



CANDLE HOLDERS - PILLAR

28" W. x 8 1/2" H. x 8" D. Holds 3" Diameter Pillar Candles
(Candles Not Included)



C-PFP-45



C-PFP-22-83



C-PFP-173



C-PFP-89



CANDLE HOLDERS - PILLAR

18 ½"W. x 5 ¼"H. x 5"D.

Holds 2" Diameter Pillar Candles.

(Candles Not Included)



CANDLE HOLDERS - PILLAR

18 1/2"W. x 5 1/4"H. x 5"D.

Holds 2" Diameter Pillar Candles.

(Candles Not Included)



C-PLB-45



C-PLB-22-83



C-PLB-89



C-PLB-173



C-PLB-264



C-PLB-276



C-PLB-272



CAT & DOG - COLLAR / LEASH HOLDERS

Sizes Range From: 4"W. x 4"H. To 4"W. x 6 1/4"H.

Product Code: WH-LC-____

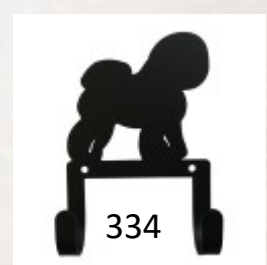
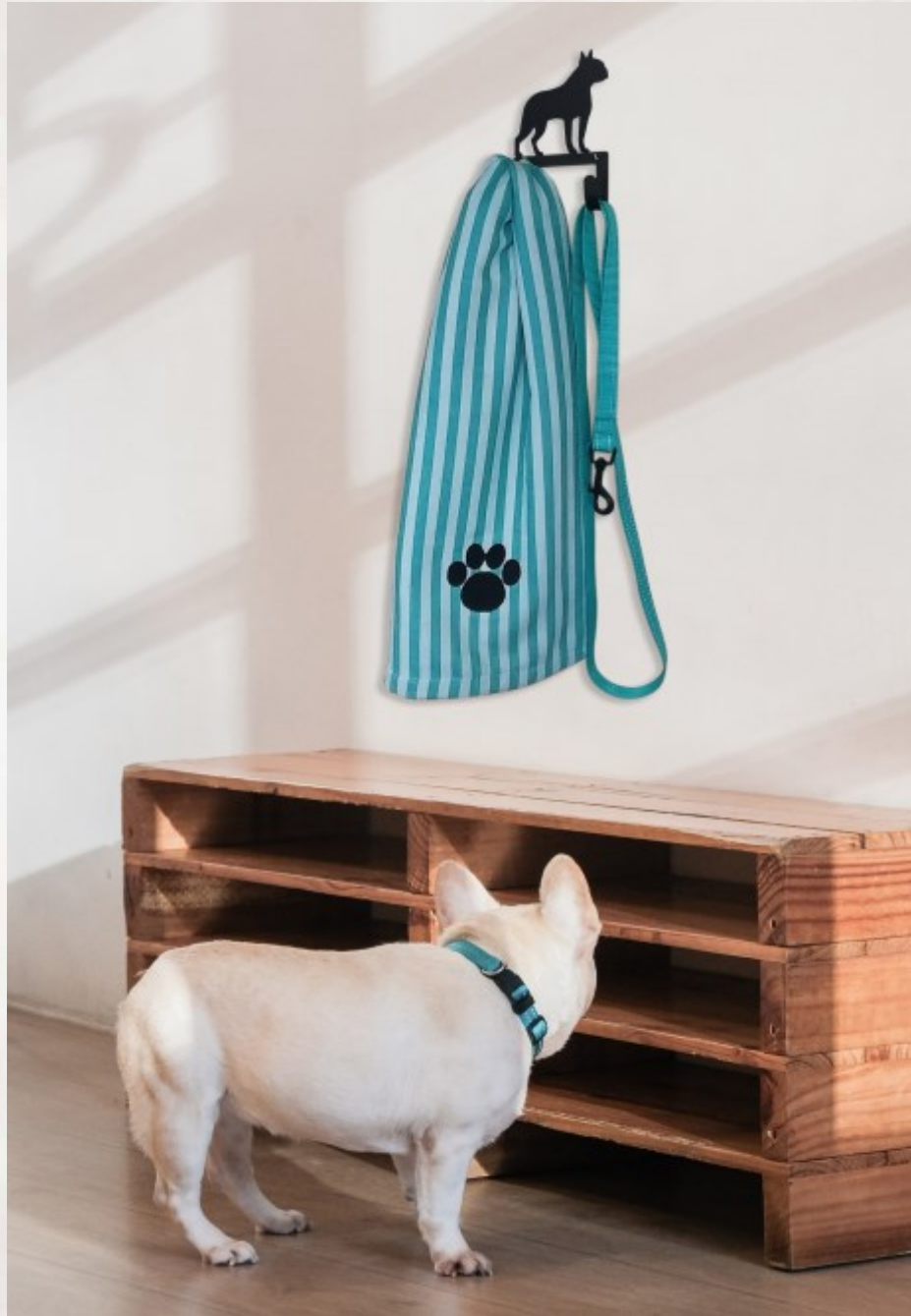
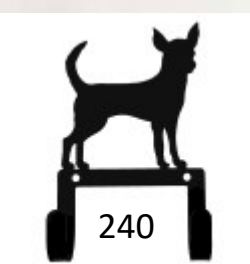

CAT & DOG - COLLAR / LEASH HOLDERS

Sizes Range From: 4"W. x 4"H. To 4"W. x 6 1/4"H.

Product Code: WH-LC-____

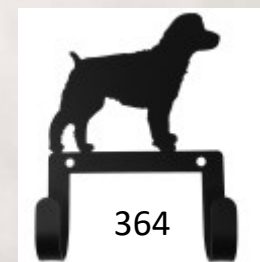
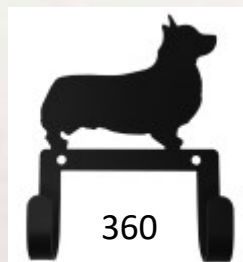
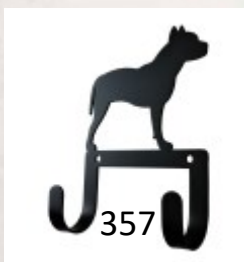
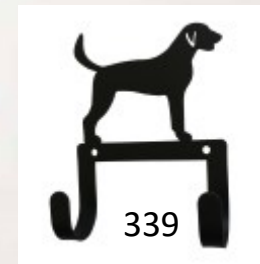
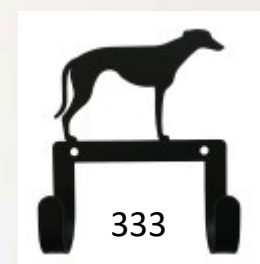
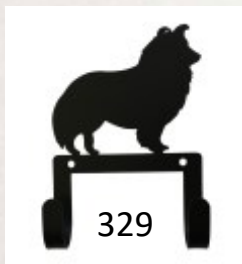
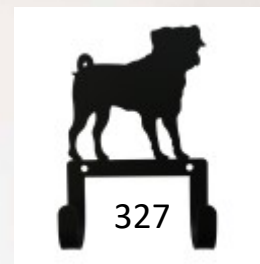
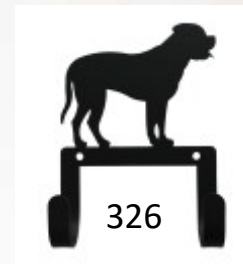



CAT & DOG - KEY HOLDERS

Sizes Range From 7 ¼" W. x 4" H. To 7 ¼" W. x 8" H.



KH-105



KH-245



KH-236

CAT & DOG - KEY HOLDERS

Sizes Range From 7 ¼" W. x 4" H. To 7 ¼" W. x 8" H.



KH-237



KH-240



KH-241



KH-242



KH-243



KH-244



KH-6



KH-246



KH-247



CAT & DOG - WALL HOOKS - SMALL

Measure approx. 3 5/8" to 5" H. Hook Depth 1 1/4" D.

Product Code: WH-___-S

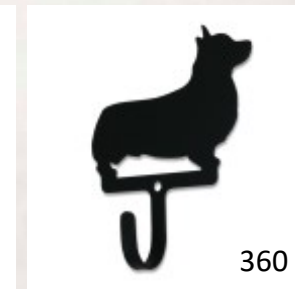
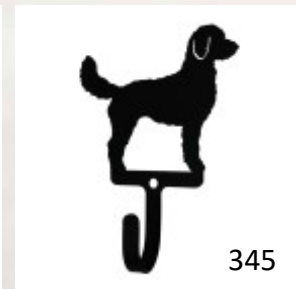
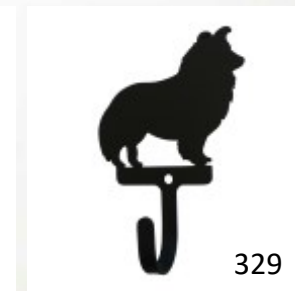
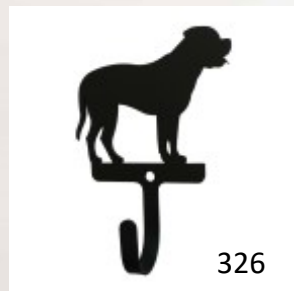
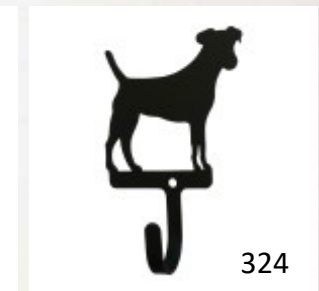
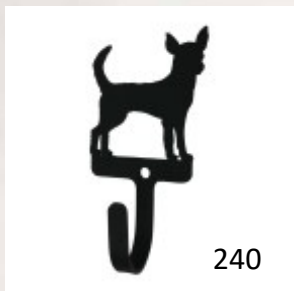
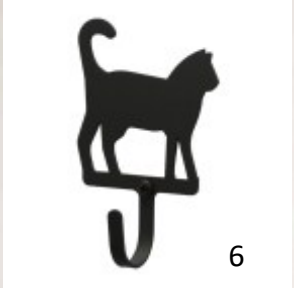

CAT & DOG - WELCOME SIGNS

Measure 11 3/8" W. x 7 7/8" H.



WEL-105-S

WEL-236-S

WEL-237-S

WEL-240-S



WEL-241-S

WEL-242-S

WEL-243-S

WEL-244-S



WEL-245-S

WEL-6-S

WEL-246-S

WEL-247-S



CUSTOMIZED COAT BARS

House Warming, Wedding , Birthday Or Any Gift.
(Please allow 4 weeks for delivery.)



Customized **5** Hook Coat Bars

Up to 18 Characters

29 1/2" W. x 7 1/2" H. x 2 1/2" D.

Product Code: CB-CUS-5



Customized **3** Hook Coat Bars

Up to 9 Characters

16" W. x 7 1/2" H. x 2 1/2" D.

Product Code: CB-CUS-3

When ordering online,
please specify characters that you would like on the Coat Bar in the special instruction box during checkout.
Spaces count as 1 character



Single Coat Hook

May Be Purchased Separately

1/2" W. x 6 1/2" H. x 3 1/4" D.

Product Code: CT-WH-1

DECORATIVE COAT BARS

These Coat Bars Will Hold 4 To 8 Coats.



4 Hook Decorative Coat Bars

Easily Holds 8 Coats.

24" W. x 8½" H. x 2½" D.

Each Hook Measures

½" W. x 5 ½" H. x 2 ½" D.



CB-3



CB-20



CB-22



CB-44



CB-68



CB-83



CB-87



CB-89



CB-109



CB-116



CB-119



CB-144



CUP - POT - UTENSIL RACK

Extremely Versatile And Extra Hooks Are Available.



CR-16
Wall Mount 16" L.
4 Movable Hooks.

CR-24
Wall Mount 24" L.
6 Movable Hooks.

CR-EXH Additional Hooks May Be Purchased Separately

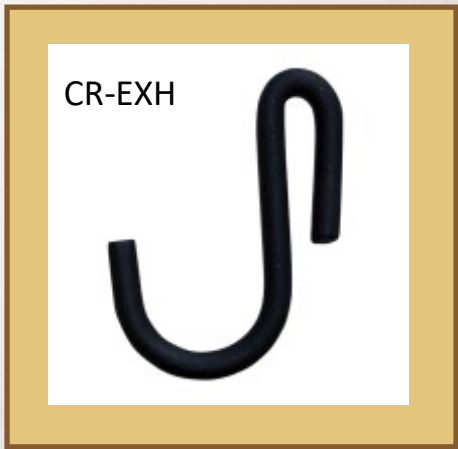

CURTAIN CRANE SETS

Includes 2 Cranes And Mounting Brackets



24" Crane Set
CUR-CRN-24

18" Crane Set
CUR-CRN-18

12" Crane Set
CUR-CRN-12

Includes 2 cranes and
mounting brackets.



CURTAIN RODS

Curtain Brackets Included With Our 1/2" Curtain Rod Sets.

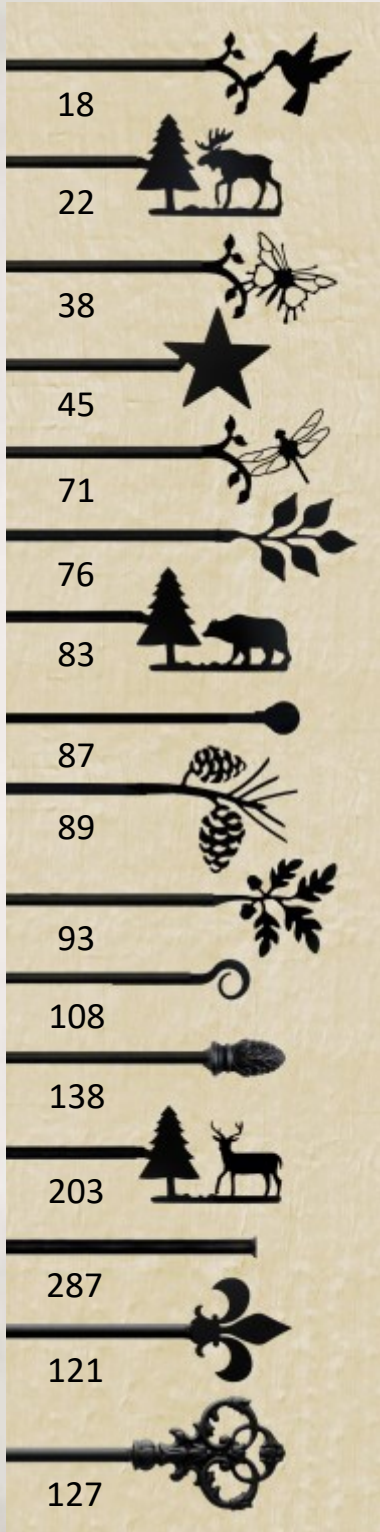

Curtain Rods Extending 21" to 35"
DO NOT Include A Center Support Bracket

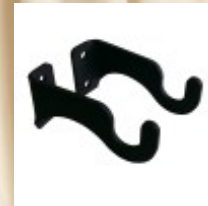

- CUR-___-35-S 21" - 35"
- CUR-___-60-S 36" - 60"
- CUR-___-112-S 61" - 112"
- CUR-___-130-S 113" - 130"

All Other Curtain Rods Include
A Pair Of Brackets AND Center Support



CURTAIN BRACKETS

Included With Our Curtain Rods.



Measurements For Curtain Brackets And Center Bracket

That Are Included With Our Curtain Rods.

Center Brackets Are Included With ALL Rods except Our Smallest Rods Extending From 21 to 35".

(Not for purchase)

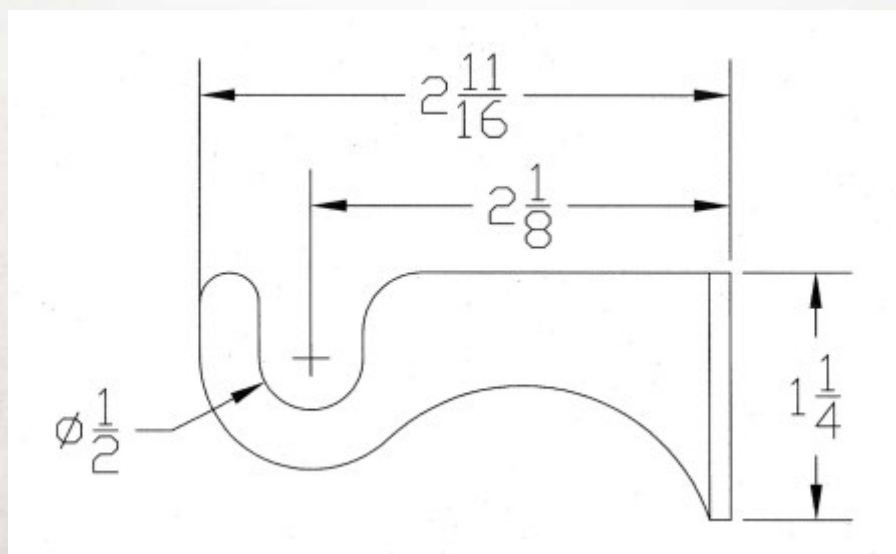
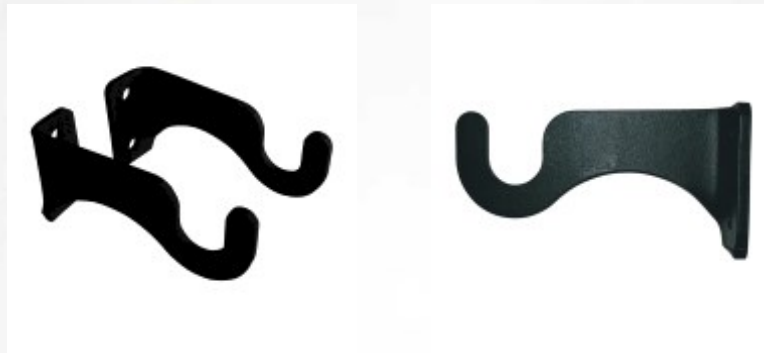



CURTAIN BRACKETS - More

All Of The Brackets Shown On This Page Fits Our 1/2" Curtain Rods.

The Double / Triple Curtain Bracket Pair
 Holds 2 or 3 Curtain Rods.
 Perfect For Layering Window Treatments.



EXTRA SMALL	REGULAR	DOUBLE	DOUBLE/TRIPLE
Curtain Bracket Pair	Curtain Bracket Pair	Curtain Bracket Pair	Curtain Bracket Pair
1 3/4" Depth	3 1/8" Depth	3 3/8" Depth	4 1/2" Depth
CUR-BRAC-XS	CUR-BRAC	CUR-BRAC-DB	CUR-BRAC-DT



EXTRA SMALL	REGULAR	DOUBLE	DOUBLE/TRIPLE
Curtain Bracket Center Support	Curtain Bracket Center Support	Curtain Bracket Center Support	Curtain Bracket Center Support
1 3/4" Depth	3 1/8" Depth	3 3/8" Depth	4 1/2" Depth
CUR-BRAC-XS-C	CUR-BRAC-C	CUR-BRAC-DB-C	CUR-BRAC-DT-C



CURTAIN RINGS

That Fit Our ½" Curtain Rods.



Curtain Clip Rings Come In A Set Of 7

1 ¼" W. x 2 ½" H.

CUR-RNG





CURTAIN SHELF BRACKETS

That Fit Our Curtain Rods.



CURTAIN SHELF BRACKETS

Showcase Any Window With Our Curtain Shelf Brackets



Curtain Shelf Brackets Sold In Pairs

Wood And Curtain Rod NOT Included

Measure Approximately 4 3/4" W. x 7 1/2" H. x 5 1/2" D.

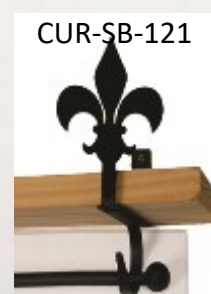
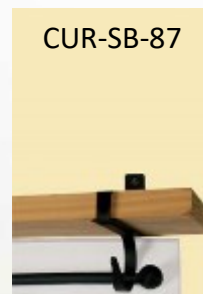
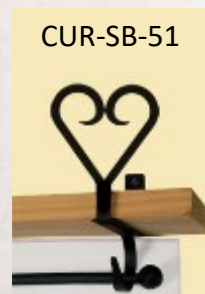

A Center Support Is Recommended For Use With Curtain Rods 61" Or Longer, And Is Sold Individually.



CURTAIN TIE BACKS

Silhouette Shapes Range From
½" W. x 2" H. To 3" W. x 8 ¼" H.



CURTAIN TIE BACKS

Silhouette Shapes Range From
1/2" W. x 2" H. To 3" W. x 8 1/4" H.



CUR-TB-1

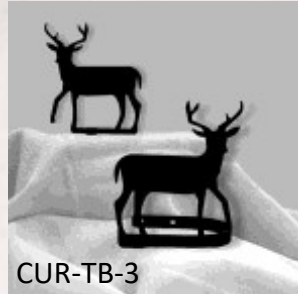

CUR-TB-3

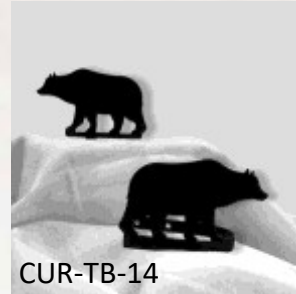

CUR-TB-14



CUR-TB-17



CUR-TB-19

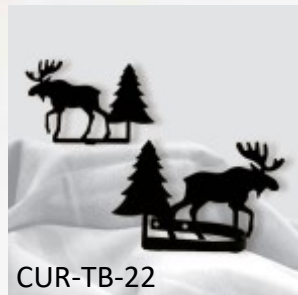

CUR-TB-22



CUR-TB-42

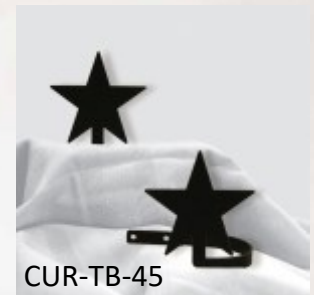

CUR-TB-45

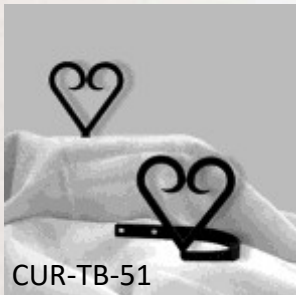

CUR-TB-51

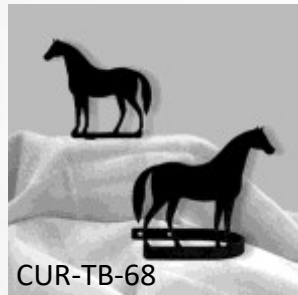

CUR-TB-68

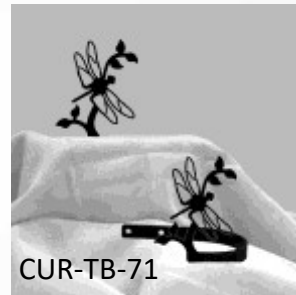

CUR-TB-71

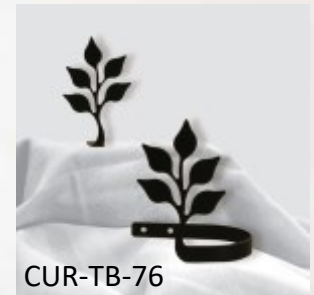

CUR-TB-76



CUR-TB-89



CUR-TB-93



CUR-TB-103

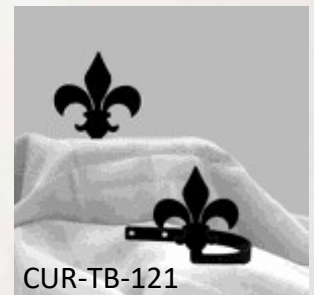

CUR-TB-121



CUR-TB-87



CUR-TB-142



CUR-TB-201

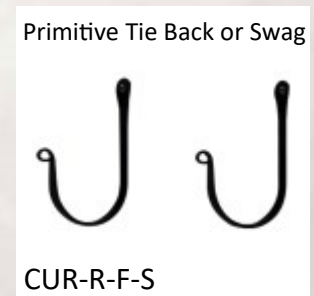

Primitive Tie Back or Swag

CUR-R-F-S



ELECTRICAL COVERS Silhouettes Available

Decorative Switch Plates & Outlet Covers.

Decorative Switch Plate & Outlet Covers

All Silhouettes Are Centered On Plate Covers.

On These Pages Are The Silhouette Numbers Listed For Ordering.



256



1

3

6

10

14

19

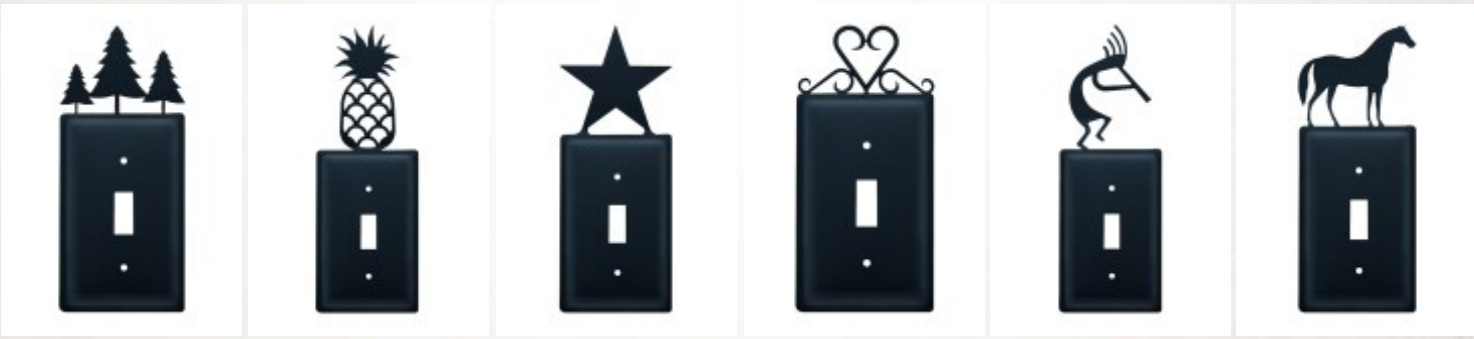

20

44

45

51

51

68



87

89

109

116

119

133

ELECTRICAL COVERS - Stock Covers

Decorative Switch Plates & Outlet Covers



Decorative Switch Plate & Outlet Covers

On This Page Are The Covers We Keep In Stock
In All The Various Silhouettes Shown On Page 24.



EO-__



ES-__



ESS-__



ESSS-__



ESSSS-__



EOS-__



EEO-__



EG-__



EGG-__

Understanding Our Electrical Product Codes



C
Stands For
Cover

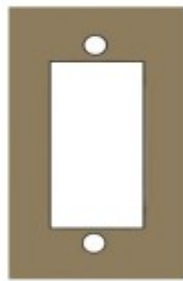

G
Stands For
GFI

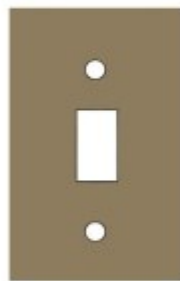

S
Stands For
Switch



O
Stands For
Outlet

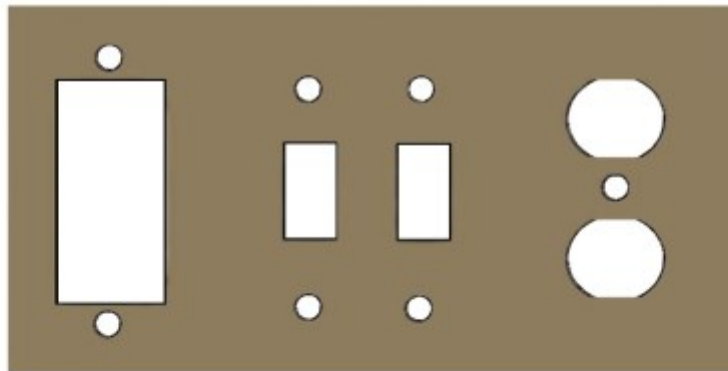

All our electrical covers begin with the product code E.

The going from left to right the codes describe what openings are featured on the cover.

The above example is EGSSO

ELECTRICAL COVERS - Custom



Combination Covers



EC-__



ECC-__



ECCC-__



ECCCC-__



EGGG-__



EGGGG-__



E000-__



E0000-__



ESSS-__



ESSSS-__

Mixed Combo Covers

Starting With EG



EGO-__



EGS-__



EGGS-__



EGOG-__



EGSG-__



EGSO-__



EGSS-__



EGGSS-__



EGSSO-__



EGSSS-__

Mixed Combo Covers

Starting With EO



EOG-__



EOGG-__



EOOG-__



EOOS-__



EOS-__

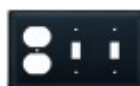

EOSS-__



EOGG-__



EOOSS-__



EOSSS-__

Mixed Combo Covers

Starting With ES



ESG-__



ES0-__



ESGO-__



ESOG-__



ESSG-__



ESSO-__



ESSSG-__



ESSSO-__

Our CUSTOM Covers Are
Made When Ordered, In All
The Various Silhouettes
Shown On Page 26.



GARDEN - HOSE HOLDERS & GUIDES

This Year, Let's Keep Your Hoses Where You Want Them.



HH-SQ-LB
½" Square Hose Holder 54" High
Holds Up To 200' Garden Hose



HH-WM
Wall Mount Hose Holder
8" High
Holds Up To 100' Garden Hose

HG-127
Decorative Hose Guide
Measures 17" High

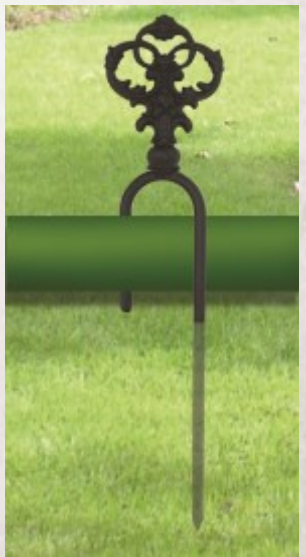

TRELLISES - NATURAL TO RUSTED TRIPOD

Approximately 58" H.



Our Tripod Trellises start out natural, with no finish and rust over time.

Degree of rust may vary at time of shipment.

Approximately 58" High.



NTR-50



NTR-127

NTR-PH



Trellis Plant Hook

Add hanging plants to your Tripod Trellises with this tension hook. Sold separately.





GARDEN - RUSTED DECORATIVE STAKES

Approximately 35" Tall.

Rusted Garden Stakes

Approximately 35" Tall



Naturally Rusted Surfaces May Vary.

This Is A
Sample Of The Color.

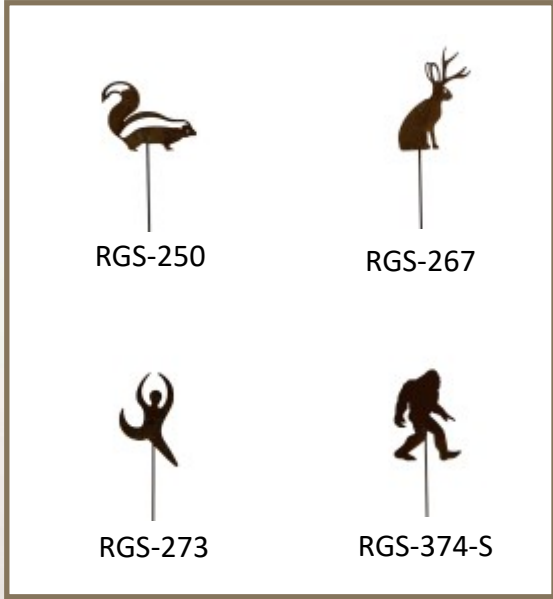

GARDEN - RUSTED DECORATIVE STAKES

Photos Are A Close Up, And Do Not Include The Entire Stake.

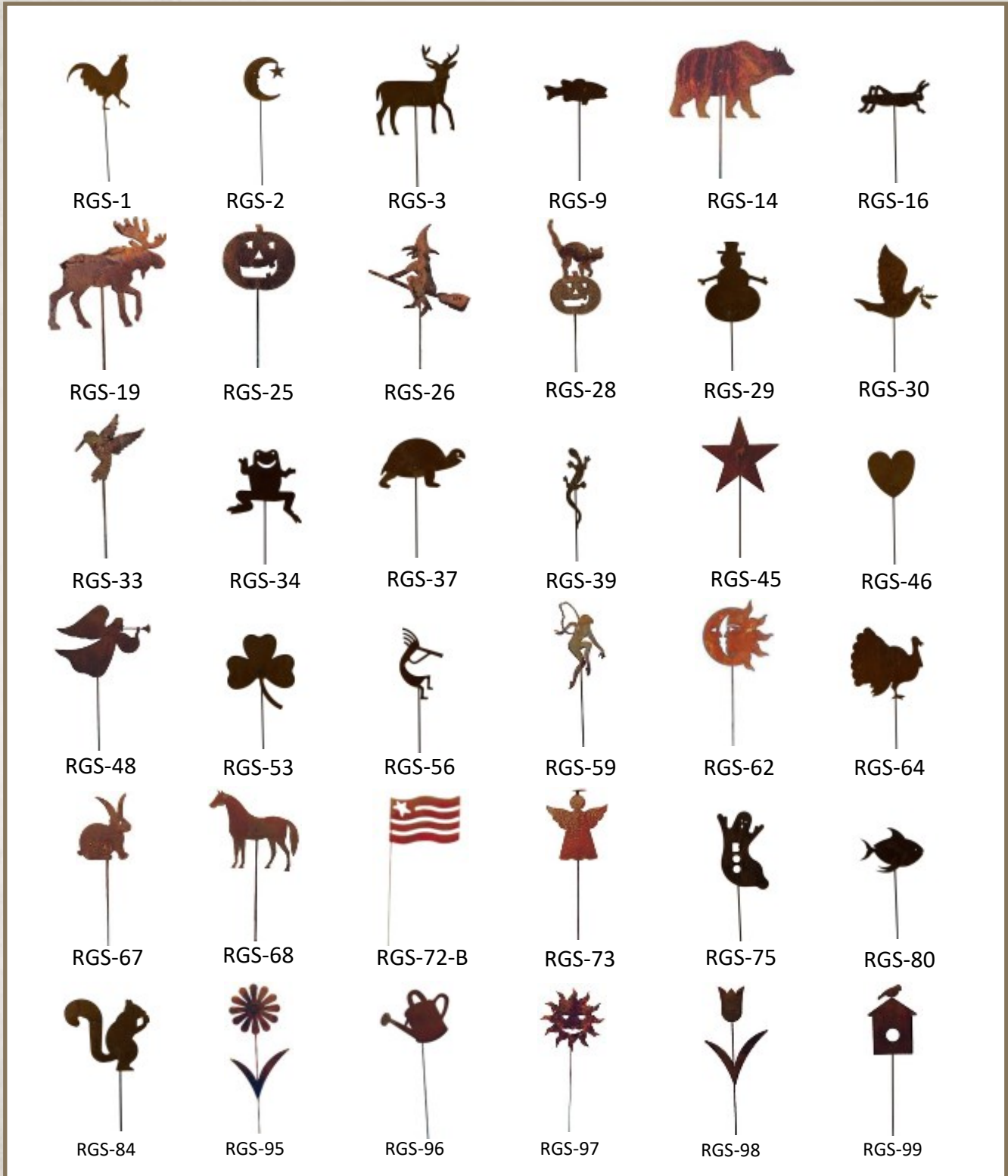



HAIR DRYER / CADDY

Holds Curling Iron & Straighteners Too

Measures 11" W. x 5" H. x 4" D.

Keep Hair Styling Accessories Handy!

Measures 11" W. x 5" H. x 4" D.



HAIR DRYER / CADDY

Holds Curling Iron & Straighteners Too
Measures 11" W. x 5" H. x 4" D.



HD-10



HD-19



HD-14



HD-38



HD-45



HD-68



HD-71



HD-89



HD-109



HD-155



HD-121



HD-173



HD-256



HARDWARE - HANDLES & KNOBS

Cabinet Door Handles and Knobs.



Choose From Our Door Knobs, Handles
(Vertical Or Horizontal)
OR Just Purchase The Silhouettes!
Silhouettes May Be Used Facing Left Or Right
To Customize Your Cabinet Hardware.

Cabinet Door Silhouettes ONLY.

Dress Up Your Existing Cabinet Hardware.

Silhouettes Measure Approx. 1 1/2" W. x 2" H.



DHK- 1

DHK- 10

DHK- 14

DHK- 19

DHK- 42

DHK- 45

DHK- 68

DHK- 109

DHK- 153

HARDWARE - HANDLES & KNOBS

Cabinet Door Handles and Knobs.



Product Code: DKP- ____



Product Code: DHP-A- ____



Product Code: DHP-B- ____



Pick The Style Of

Cabinet Door Knob Or Handle...

DKP- ____

DHP-A- ____

DHP-B- ____

Then The Silhouette Number From Below

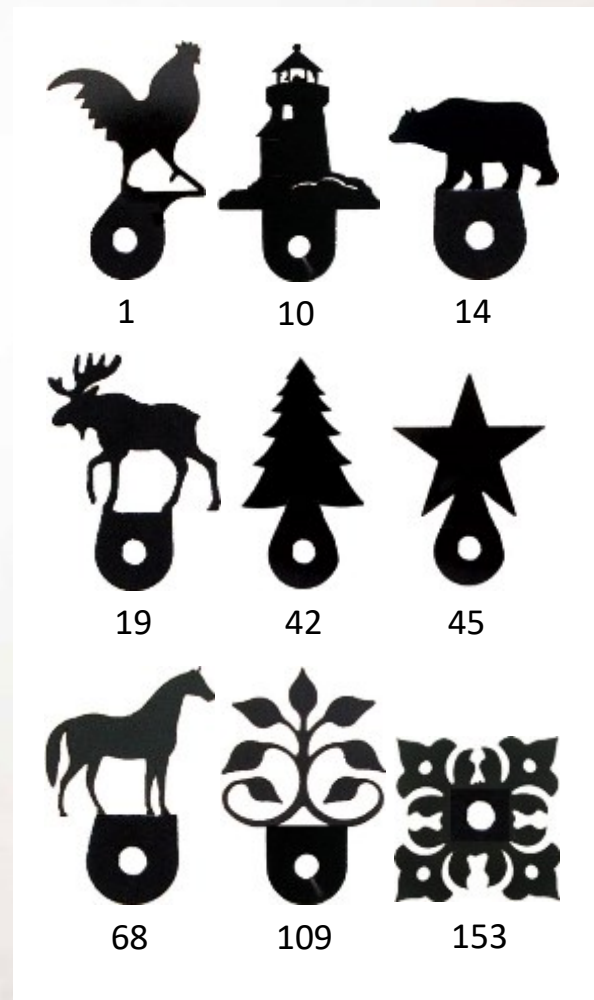



HOUSE LETTERS AND NUMBERS

For Business and Residential Use.

Letters and Numbers

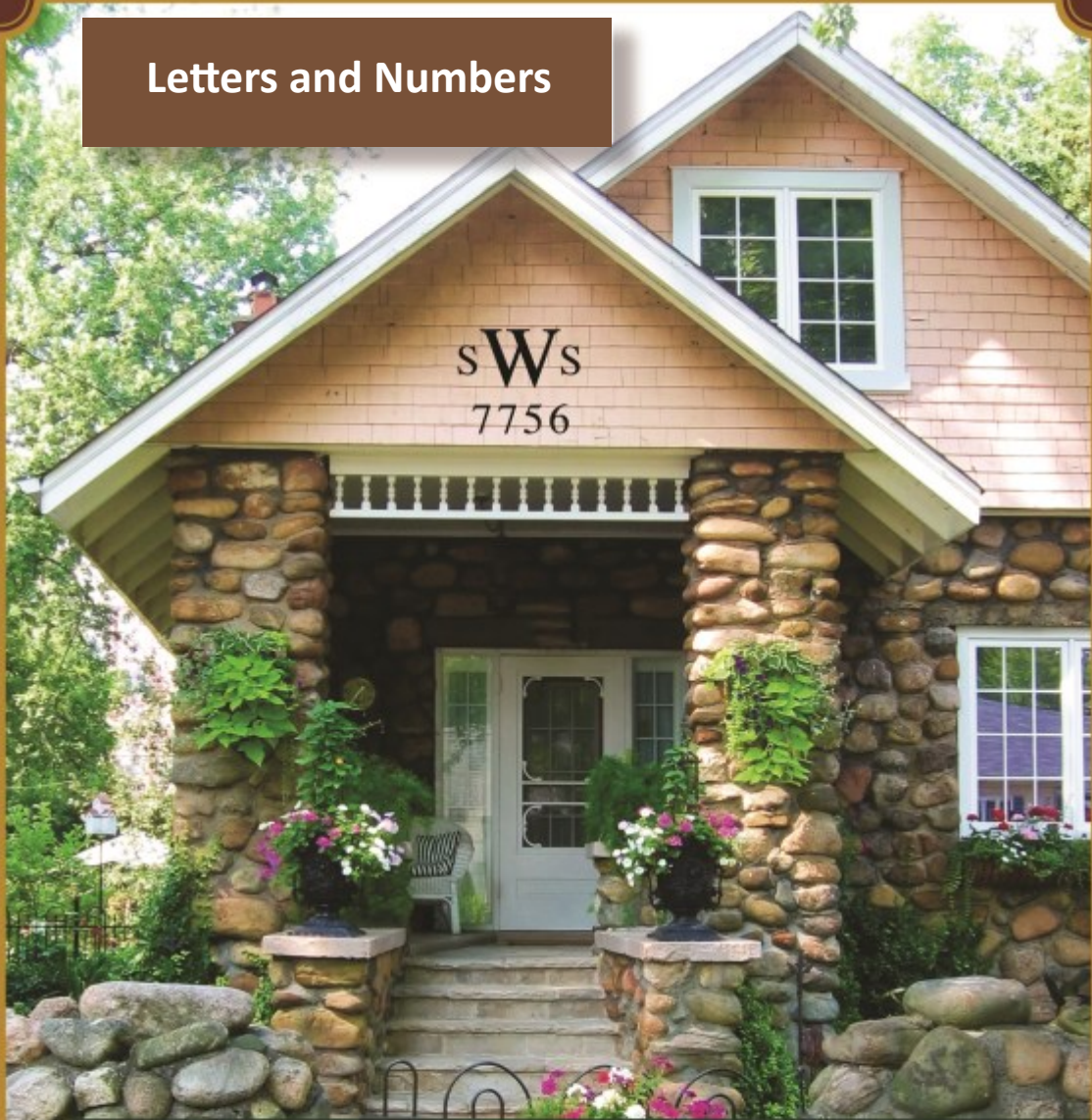

ABC ABC ABC

HOUSE LETTERS AND NUMBERS

Three Different Sizes For Letters, Two Sizes For Numbers.



ABCDEF G
HIJKLMN
OPQRSTU
VWXYZ &

1234567890

6 " Height

Product Codes:

LET- Choose Letter -S

NUM- Choose Number -S

12 " Height

Product Codes:

LET- Choose Letter -M

NUM- Choose Number -M

18 " Height

Product Codes:

LET- Choose Letter

Numbers NOT Available In 18"



HOUSE PLAQUES - CUSTOM

Custom House Plaques Are Available
In The Silhouettes Shown With Up To 13 Characters.
Each Space Counts As A Character.



HOUSE PLAQUES - CUSTOM



HP-1



HP-203

Measures 22" W. x 7 1/2" H.

2 - 3 Weeks For Delivery.



HP-6



HP-10



HP-19



HP-20



HP-22



HP-44



HP-68



HP-83



HP-87



HP-105



HP-116



HP-133



HP-139



HP-155



HP-186



KEY CHAINS

Key Chains Are BLACK Unless Otherwise Shown.



KC-2



KC-6



KC-10



KC-14



KC-19



KC-26



KC-38



KC-39



KC-40



KC-46



KC-51R



KC-53G



KC-56



KC-59



KC-68



KC-70



KC-71



KC-105



KC-111R



KC-134

KEY HOLDERS... and so much more!

Sizes Range From 7 3/4" W. x 4" H To 7 3/4"W. x 8" H.



KH-151



KH-51





KEY HOLDERS... and so much more

Sizes Range From 7 3/4" W. x 4" H To 7 3/4"W. x 8" H.



KH-1

KH-3

KH-5

KH-6

KH-10



KH-12

KH-14

KH-15

KH-17

KH-18



KH-19

KH-20

KH-22

KH-38

KH-44



KH-45

KH-51

KH-56

KH-68

KH-71

KEY HOLDERS... and so much more

Sizes Range From 7 3/4" W. x 4" H To 7 3/4"W. x 8" H.



KH-89

KH-93

KH-102

KH-104

KH-105



KH-109

KH-110

KH-116

KH-119

KH-121



KH-129

KH-133

KH-134

KH-139

KH-144



KH-151

KH-155

KH-157

KH-186

KH-249

KEY HOLDERS - DOGS AND CATS

Sizes Range From 7 3/4" W. x 4" H To 7 3/4"W. x 8" H.



KH-105

KH-236

KH-237

KH-240



KH-241

KH-242

KH-243

KH-244

KH-245



KH-6

KH-246

KH-247

KEY HOLDERS - SPORTS

Sizes Range From 7 ¾" W. x 4" H To 7 ¾"W. x 8" H.



KH-135



KH-158



KH-179



KH-182



KH-183



KH-191



KH-192



KH-195

MANTLE HOOKS

Measure Approximately 9" High Including Silhouette.
Hook To Silhouette Measures 5" High.

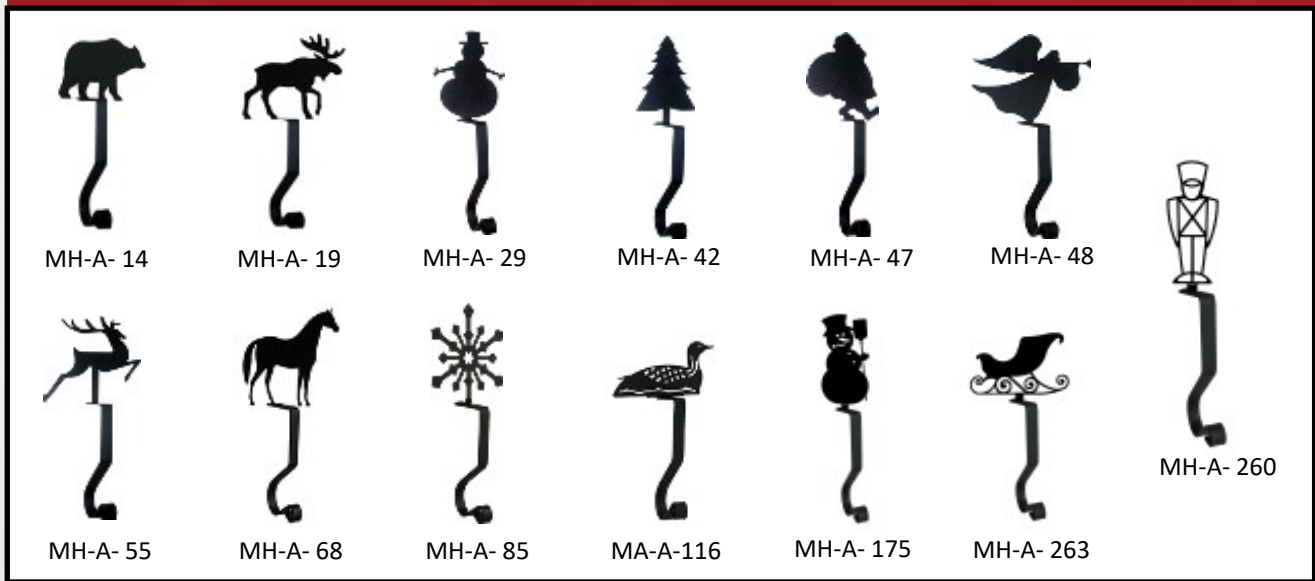

Our Traditional Mantle Hooks
Are Available in three sizes.

- 5" H MH-F-5
- 8" H MH-F-8
- 11" H MH-F-11

MITTEN & BOOT DRYING STANDS

Our stands are so sturdy that even ADULT work boots fit!



Mitten/Boot Dryer Stand

12"W. x 39"H.

Holds 4 Pair

of mittens or boots

Available in Heart Top ONLY

Product Code: MD-S-4-51



Mitten/Boot Dryer Stands

12" W. x 39"H. - **Holds 8 Pair**



MD-S-8-50



MD-S-8-150



MD-S-8-85



MD-S-8-51



MD-S-8-175



NAPKIN HOLDERS

5" W. x 5 1/2" H. x 2 1/4" D.



NH-1



NH-2



NH-3



NH-5



NH-6



NH-10



NH-14



NH-19



NAPKIN HOLDERS

5" W. x 5 1/2" H. x 2 1/4" D.



NH-18



NH-20



NH-38



NH-44

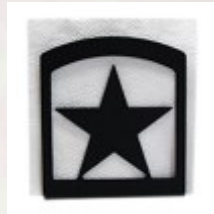

NH-45

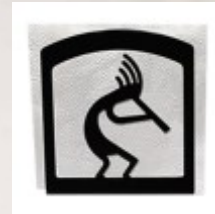

NH-56



NH-66



NH-68



NH-70



NH-71



NH-76



NH-89



NH-91



NH-93



NH-105



NH-109



NH-110

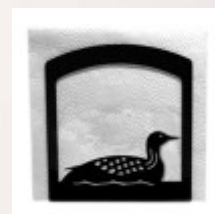

NH-116



NH-119



NH-133



NH-134



NH-139

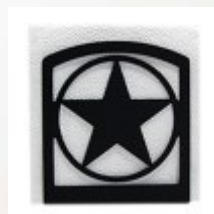

NH-144



NH-121



NH-155



NH-157



NH-164



NH-186



NH-249



NH-341

NAPKIN RINGS

Approximate Size 2 ¼" W. x 2 ¼" H. x 1 ¾" D.



NR-1



NR-14



NR-19



NR-38



NR-42



NR-45



NR-46



NR-68



NR-70



NR-71



NR-85



NR-121

ORGANIZE

It's FUN and it's EASY.

(Accessories NOT Included.)



TT-87

___" W. x ___" H. x ___" D.

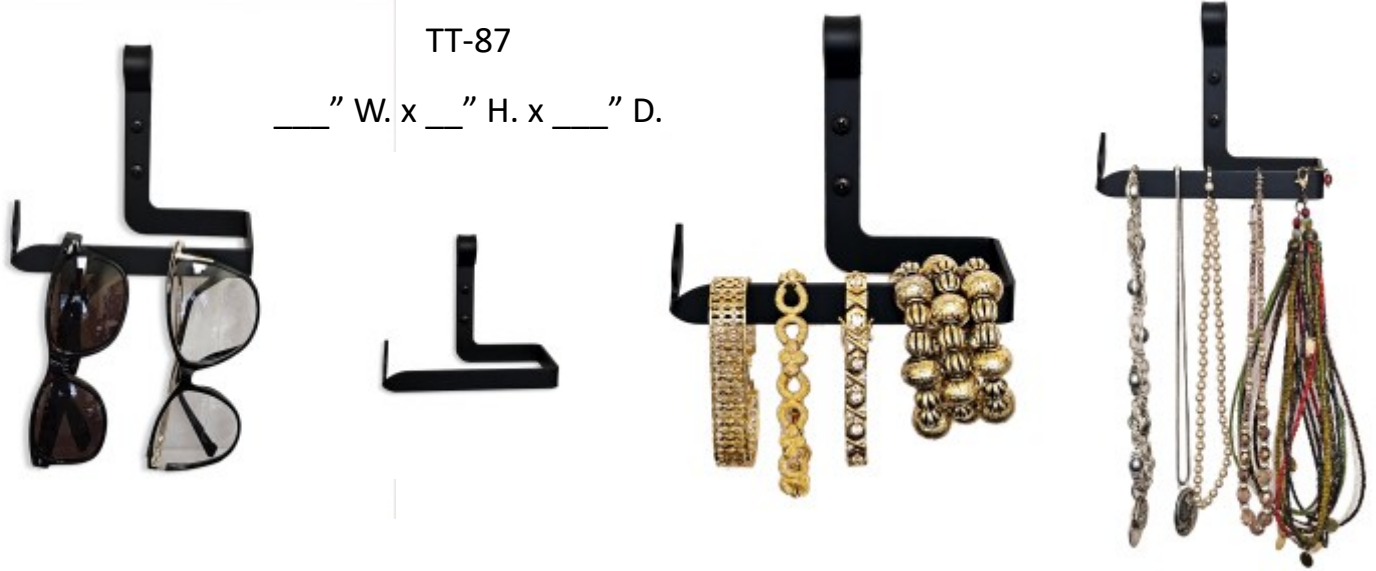

PT-B-87

12" W. x ___" H. x 4" D.

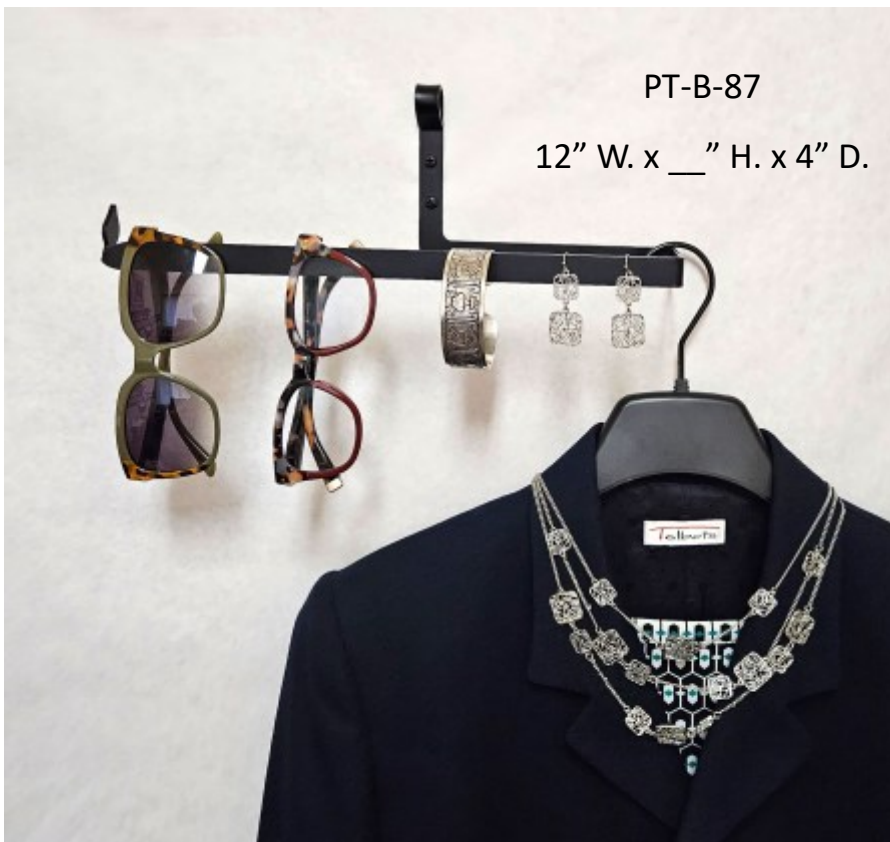



PAPER TOWEL HOLDER - WALL MOUNT

Approximately 4" W. x 13 H. x 6" D.



PT-A-1



PT-A-10



PT-A-14



PT-A-19



PT-A-45



PT-A-51



PT-A-87



PT-A-89



PT-A-121

PAPER TOWEL HOLDER - WALL MOUNT

Approximate Size 12" W. x 8 ¼" H. x 4" D.



PT-B-256



PT-B-1



PT-B-14



PT-B-19

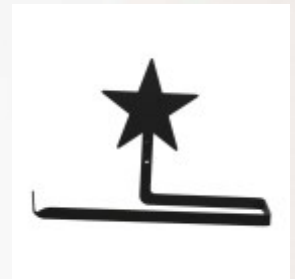

PT-B-45

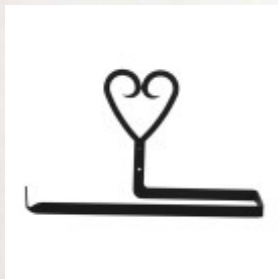

PT-B-51

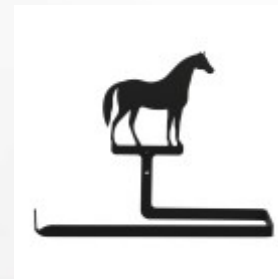

PT-B-68



PT-B-76



PT-B-87

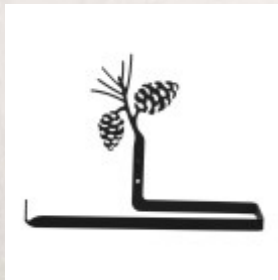

PT-B-89



PT-B-93

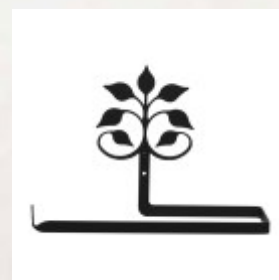

PT-B-109

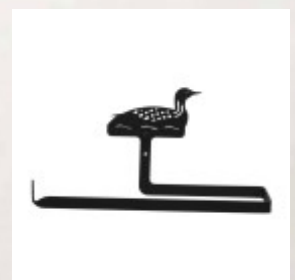

PT-B-116



PAPER TOWEL HOLDER - COUNTER TOP

Approximate Size 6" W. x 14" H. x 6" D.

Paper Towel Holders Are Perfect For Your...
Kitchen - Bathroom - Laundry Room - Work Shop

Product Code: PT-C-____



PAPER TOWEL & RECIPE CARD HOLDER

Hangs on your cabinet handle or knob.



Measures 3" W. x 7" H.

Product Code:

RC-H



PT-C-109

PLANT HANGERS - FLAT IRON

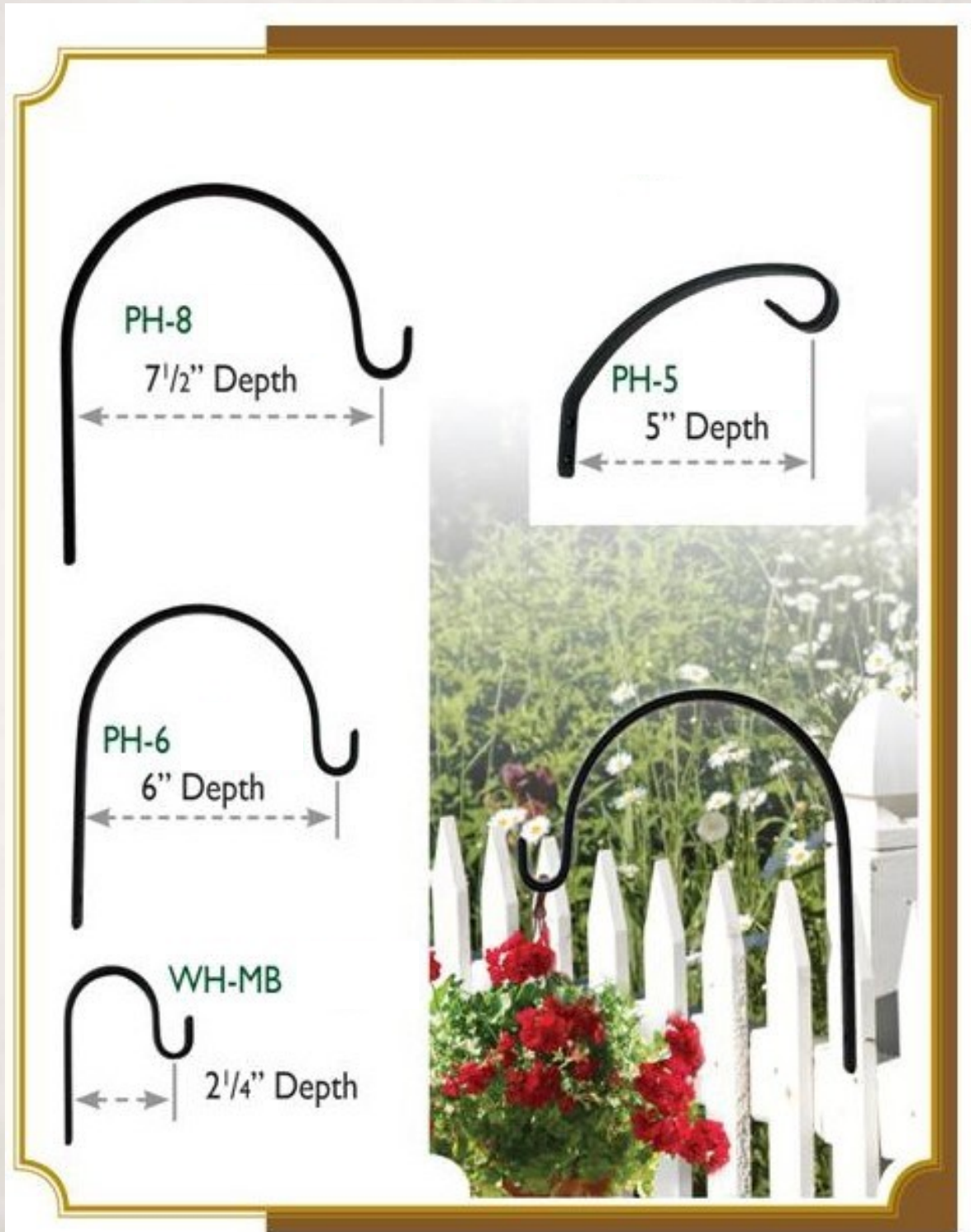

PLANT HANGERS - REMOVABLE

Round and Square Iron

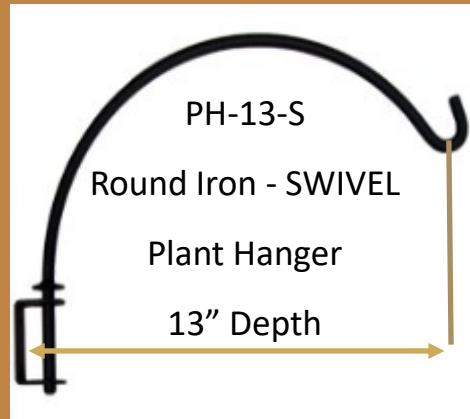

Square Iron:

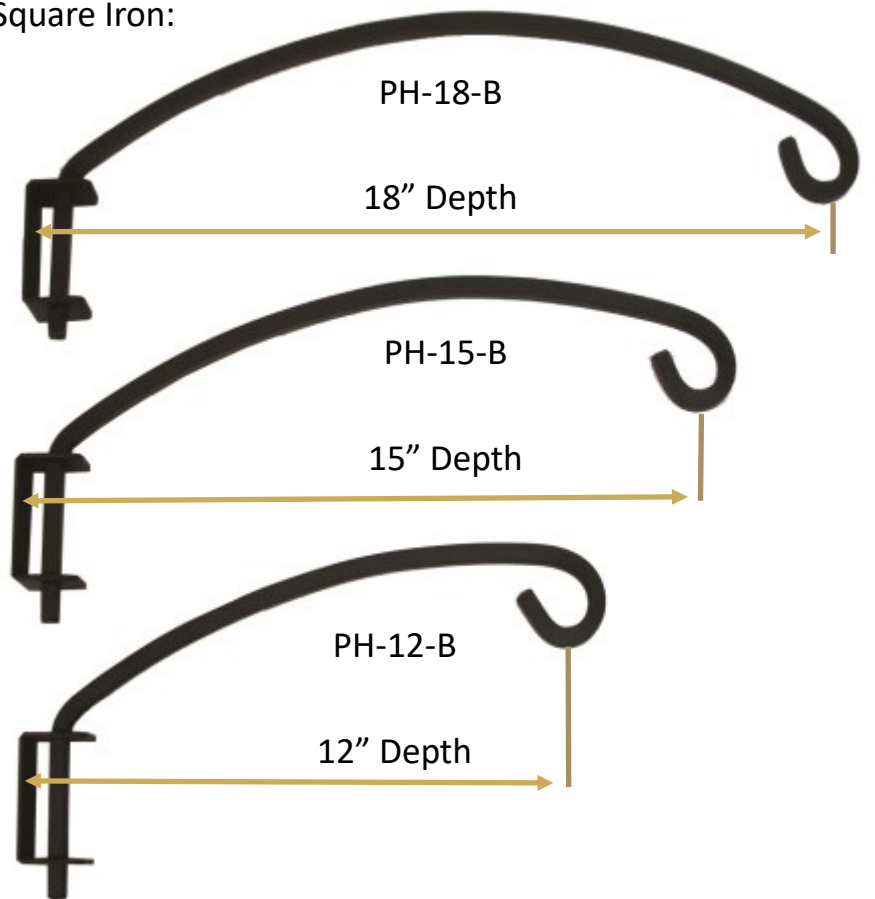



PLANT HANGERS - SQUARE IRON

10" H x 1 7/8" W. x 12" D.

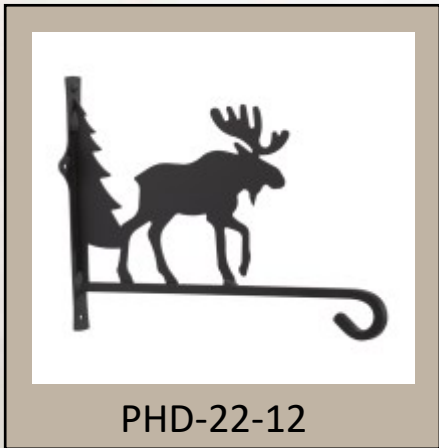

PHD-22-12



PHD-83-12

PLAQUES A - Z

24" W. x 11" H. Use Indoors or Outdoors.

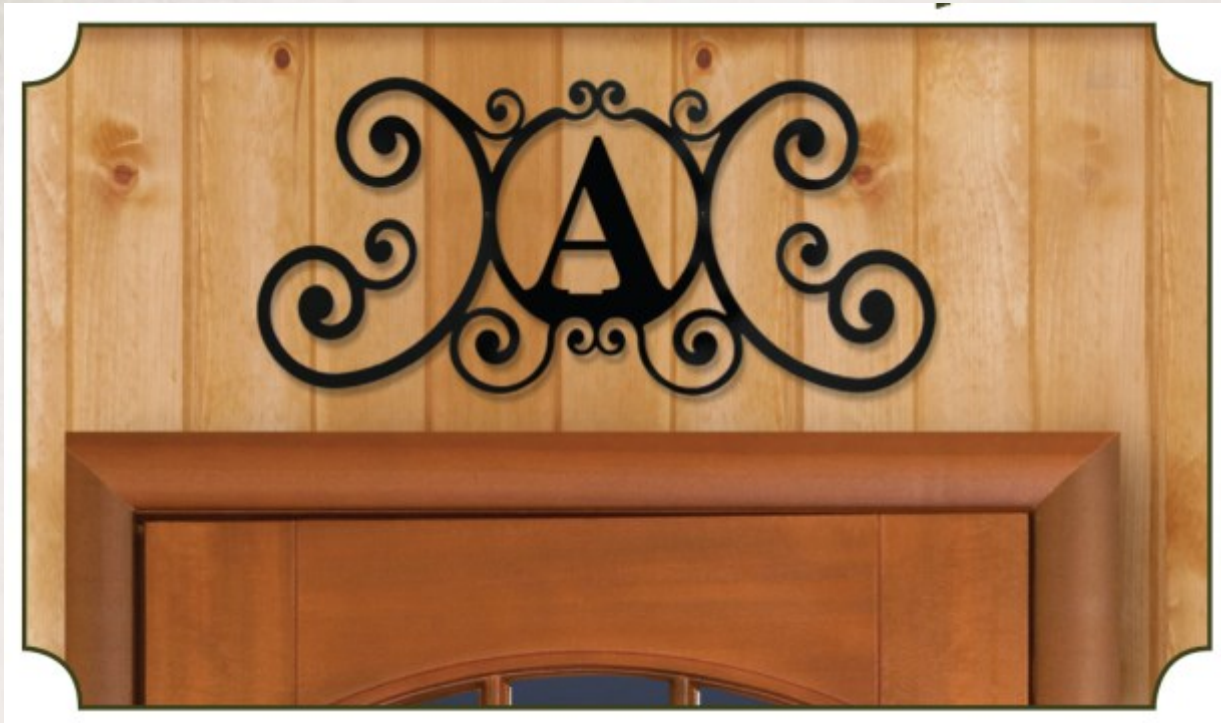

Product Code: HP-OD-____(Choose Letter)

ABCDEFGHIJKLMNOPQRSTUVWXYZ

PLAQUES - OUTSIDE OR INSIDE

24"W x 11" H.



HP-OD-1



HP-OD-3



HP-OD-19



HP-OD-68



HP-OD-105



HP-OD-10



HP-OD-38



HP-OD-71



HP-OD-116



HP-OD-14



HP-OD-44



HP-OD-45



HP-OD-201

RECYCLE BINS

Measure 17 1/2" w. x 11" H. x 14 3/4" D.



Attractive and Functional
Recycle in style!



RB-93



RB-87



RB-100-101



RB-109

S - Hooks

Hang Plants, Dried Herbs & Flowers Even Pots or Pans.

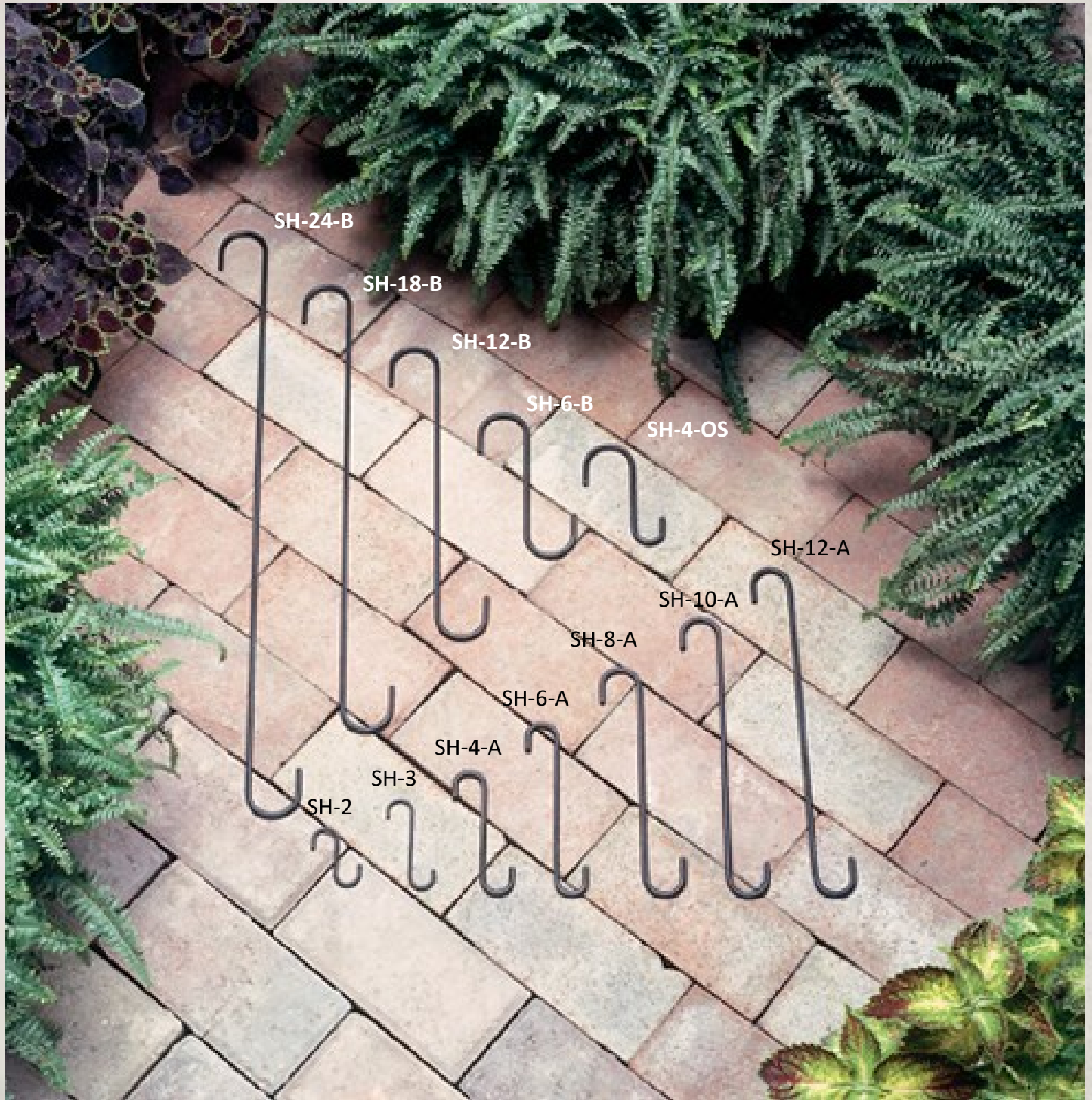

S - Hooks

Perfect for Hanging ANYTHING.



Product Code	Description
SH-2	2" L. with $\frac{5}{8}$ " Hook Depth
SH-3	3" L. with $\frac{5}{8}$ " Hook Depth
SH-4-A	4" L. with $\frac{3}{4}$ " Hook Depth
SH-4-OS	4" L. with $\frac{3}{4}$ " Hook Depth and 1 $\frac{3}{8}$ " Hook Depth
SH-6-A	6" L. with $\frac{3}{4}$ " W. Hook Depth
SH-6-B	6" L. with 1 $\frac{3}{4}$ " W. Hook Depth
SH-8-A	8" L. with 1" W. Hook Depth
SH-10-A	10" L. with $\frac{3}{4}$ " W. Hook Depth
SH-12-A	12" L. with 1" W. Hook Depth
SH-12-B	12" L. with 1 $\frac{1}{2}$ " W. Hook Depth
SH-18-B	18" L. with 1 $\frac{3}{4}$ " W. Hook Depth
SH-24-B	24" L. with 1 $\frac{1}{2}$ " W. Hook Depth



S - CHAINS

S-Chain

Each S-Chain Hook Measures

2 1/2" L. x 5/8" W.

Create your own length

Sold Individually

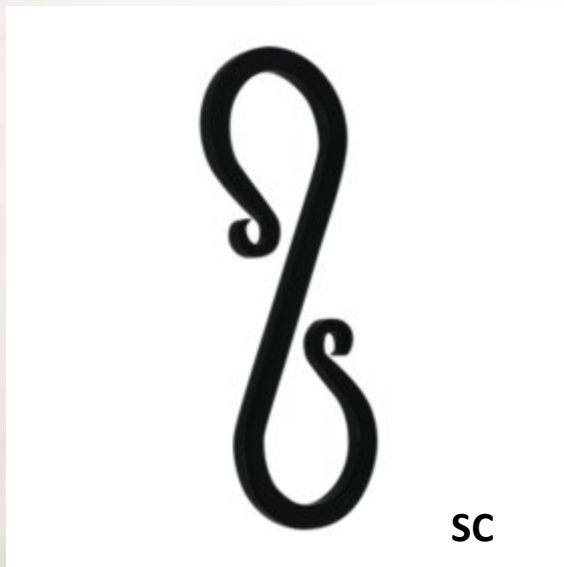

S - HOOKS - DECORATIVE

Lowering anything to the height you want. 12" High





SHELF BRACKETS

Three Different Sizes

Product Code - SB-__-L

Large Shelf Brackets

Measure 9 1/4" H. x 9 1/4" W.

Holds a 10" Board

Product Code - SB-__-M

Medium Shelf Brackets

Measure 7 1/4" H. 7 1/4" W.

Holds a 8" Board

Product Code - SB-__-S

Medium Shelf Brackets

Measure 5 1/4" H. 5 1/4" W.

Holds a 6" Board

Sold in Pairs - Wood not included.

SHELF BRACKETS

Three Different Sizes





SELF BRACKETS - EXTRA HEAVY

Measurements 9 1/2" L. x 9 1/2" H. x 1 1/2" W.

Extra-Heavy Shelf Bracket Pair

Measurements of mounting sides are 9 1/2" L. x 9 1/2" H. x 1 1/2" W.



SB-109-L-HEAVY



Two Styles

To

Choose From!

SELF BRACKETS - EXTRA HEAVY

Measurements 9 1/2" L. x 9 1/2" H. x 1 1/2" W.



SB-87-L-HEAVY

Backside
Of Shelf



SB-109-L-HEAVY



SIGN BRACKETS
Available in Three Sizes



SIGN BRACKETS

Available in Three Sizes



SGB-103-18

18" L. x 11" H.

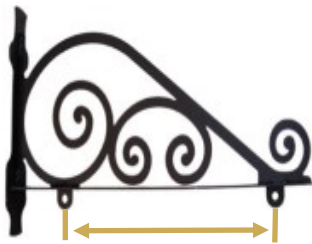

12 $\frac{3}{8}$ "

SMALL

Sign Bracket

Holes for Hanging
are
 $\frac{3}{4}$ " Diam.

SGB-103-24

24" L. x 14" H.

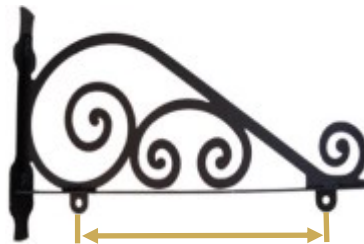

16 $\frac{1}{2}$ "

MEDIUM

Sign Bracket

Holes for Hanging
are
 $\frac{1}{2}$ " Diam.

SGB-103-36

36" L. x 19" H.

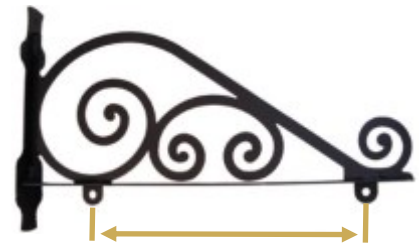

24 $\frac{7}{8}$ "

LARGE

Sign Bracket

Holes for Hanging
are
 $\frac{1}{2}$ " Diam.

SILHOUETTES - DECORATIVE

Measure Approximately 12" W. x 17" H.

Product Code: HOS- _ _ _

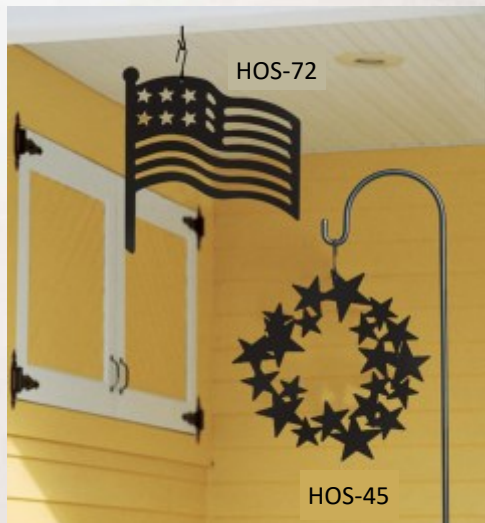
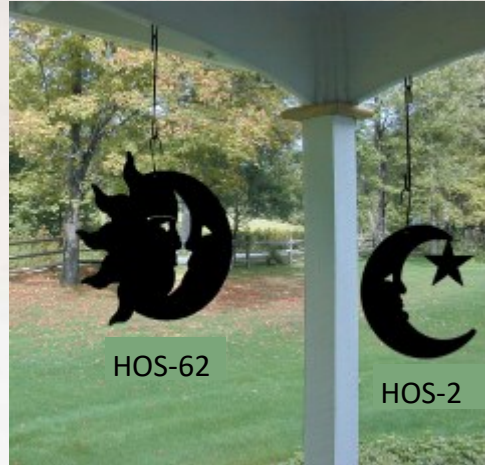
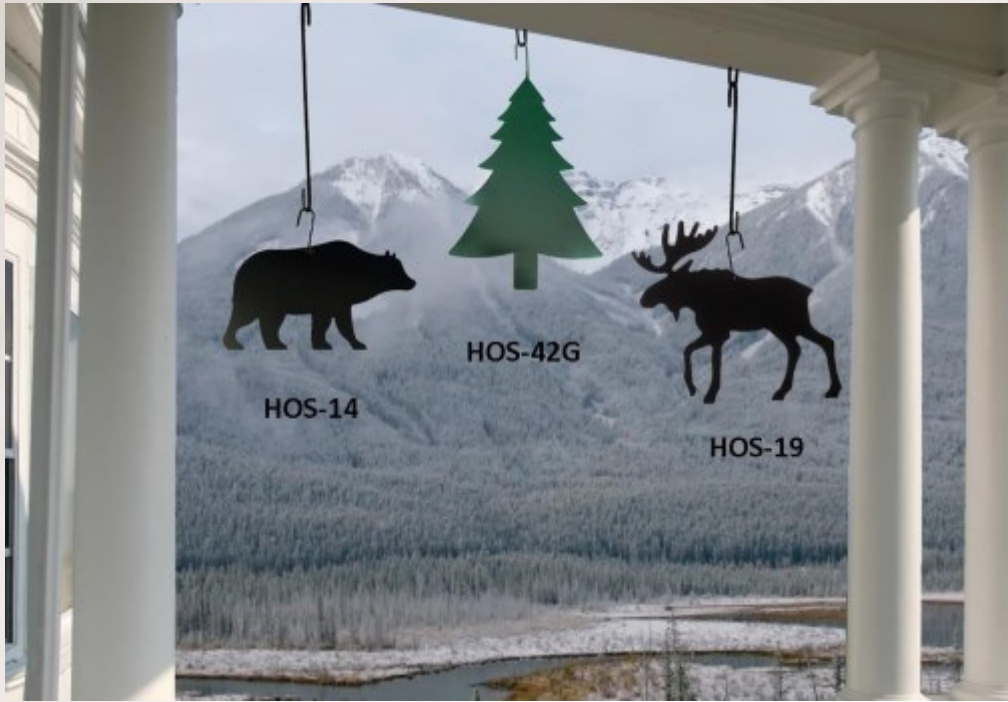

SILHOUETTES - DECORATIVE

Measure Approximately 12" W. x 17" H.
Product Code: HOS- _____





SCHOOL FUNDRAISING

Key Chain for your School or Organization.
Contact Us for More Information.

SHOW YOUR SCHOOL SPIRIT!

Support our school with custom key chains!

MADE IN U.S.A.

Each key chain is made of quality domestic wrought iron with a baked on powder coating, for long lasting durability.

All key chains are manufactured in Central New York by Village Wrought Iron, Inc.

ORDER YOUR KEY CHAINS TODAY! (see reverse side for details)

SNOW GAUGES

2" and 3" Tall



2' Snow Gauge

4" W.

SG-85-S

3' Snow Gauge

4" W.

SG-85-M

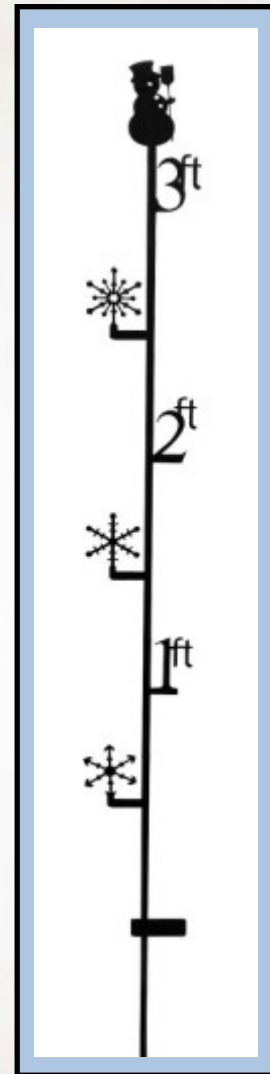

Snowman

3 Foot Snow Gauge

4" W.

SG-175-M



SPORTS - MEN'S - KEY HOLDERS

Sizes Range From
7 3/4" W. x 4" H. to 7 3/4" W. x 8" H.



KH-135



KH-151



KH-158



KH-179



KH-182



KH-183



KH-191



KH-192



KH-195

SPORTS - MEN'S - WALL HOOKS - SM

Measure Approx. 4 1/2" to 5" H.



Measure Approximately

4 1/2" to 5" H.

Hook Depth Measures 1 1/4" D.

Product Code: WH-____-S

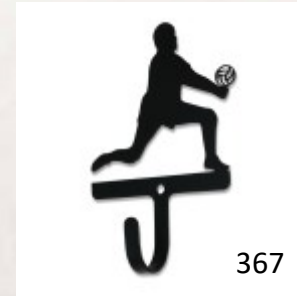
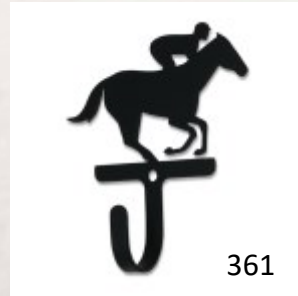
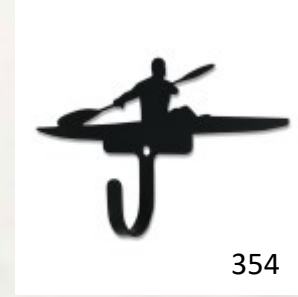
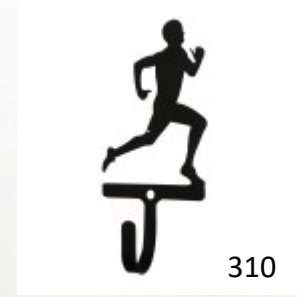
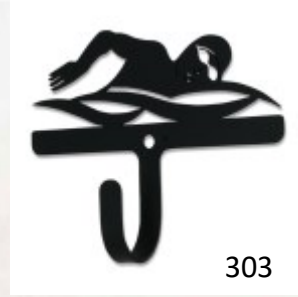
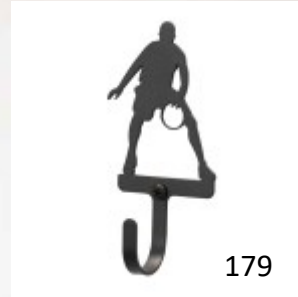
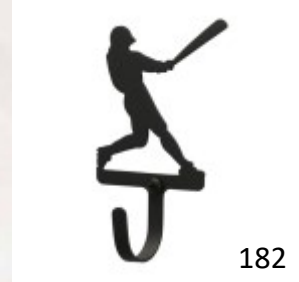



SPORTS - WOMAN'S - WALL HOOKS - SM





















Product Code: WH-LC-___

Measure Approximately

4 1/2" to 5" H.

Hook Depth Measures 1 1/4" D.



 389	 269	 284	 289	 290
 293	 302	 303	 304	 305
 306	 307	 311	 316	 354
 356	 359	 361	 362	 376

THE OUTHOUSE

Many of our products for your new OUTHOUSE.



Complete List
Of Switch & Outlet
Covers
See Page 26 - 29

ES-256



EG-256



EO-256



ESS-256



EEO-256



ESSS-256



Towel Bar Small

18" W. x 7" H.

TB-256-S



Towel Bar Large

24" W x 7" H.

TB-256-L



Toilet Tissue Holder

5 1/4" W. x 7 7/8" H.

TT-256



Paper Towel Holder

12" W. x 8" H.

PT-B-256



Towel Ring

5 1/2" W. x 12" H.

TBR-256



Toilet Tissue Holder w/
Roll

5 1/4" W. x 7 3/4" H.



Wall Hook Small

2 1/2" W. x 5" H.

WH-256-S



TOILET TISSUE HOLDERS

TWO DIFFERENT STYLES to choose from.
ROLLER STYLE - Roller Included



TT-B-68

TT-B-116



TT-B-155

TT-B-256



TT-B-51

TT-B-76

TT-B-87

TT-B-89

TT-B-109

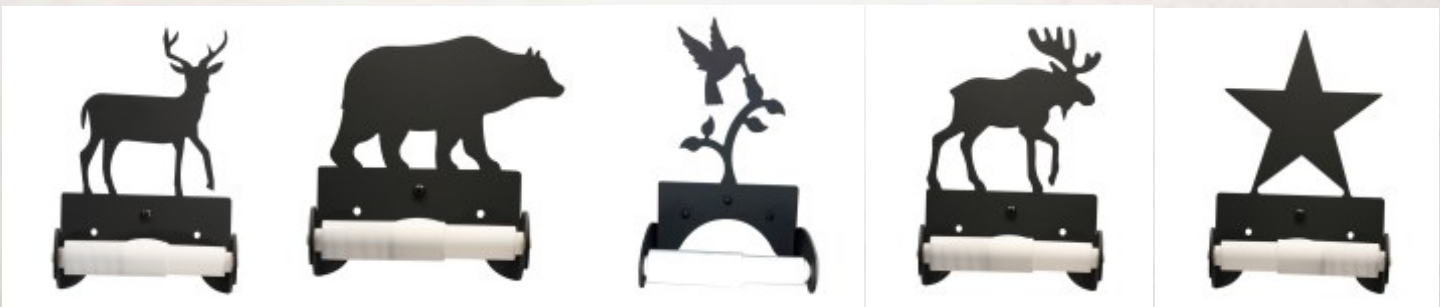

TT-B-3

TT-B-14

TT-B-18

TT-B-19

TT-B-45

TOILET TISSUE HOLDERS

Holders Range from 6" H. To 10" H.

TRADITIONAL STYLE



TT-3



TT-14



TT-18



TT-19



TT-45



TT-51



TT-68



TT-76



TT-87



TT-89



TT-109



TT-116



TT-155

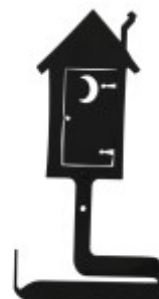

TT-256



TOWEL BARS

Available in Small and Large.

SMALL - Towel Bars

Rod Length 18" L

3" Depth

LARGE - Towel Bars

Rod Length 24" L

3" Depth

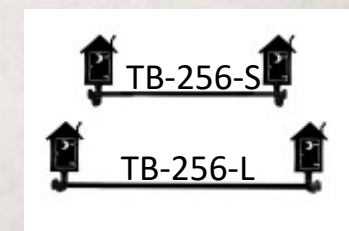
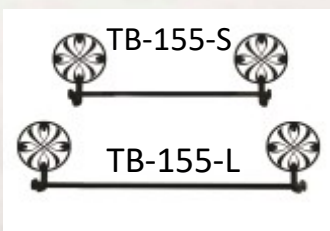
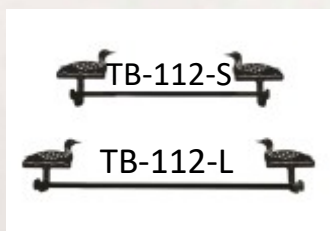
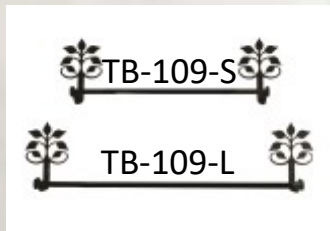
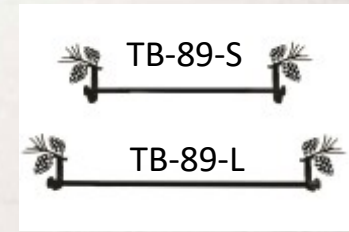
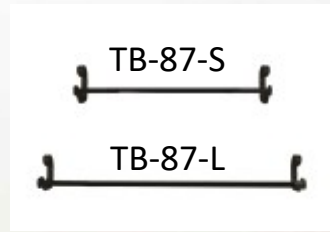
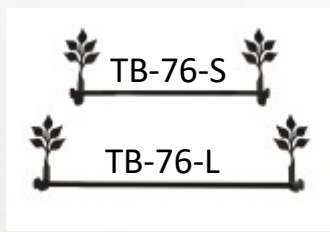
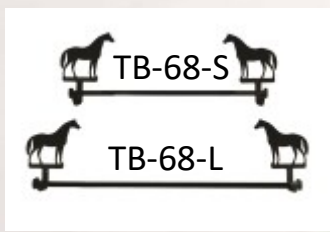
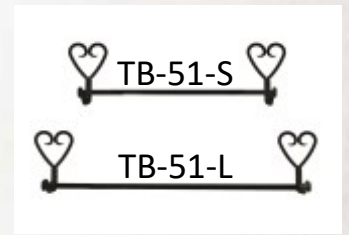
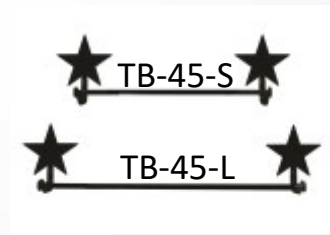
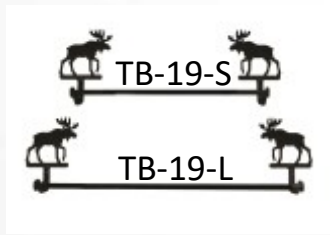
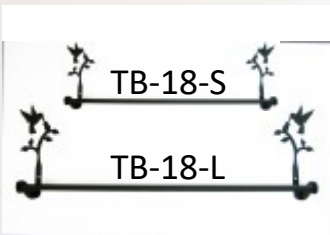
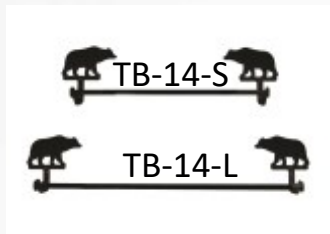
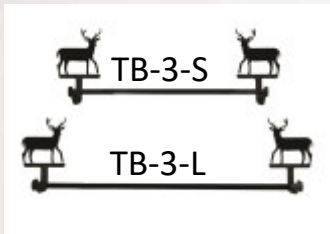

TOWEL RINGS

For Bath and Hand / Kitchen Towels

Sizes Range from 13 1/2" H. to 18 1/2" H. Towel Ring is 5"



TBR-3



TBR-14



TBR-19



TBR-45



TBR-51



TBR-68



TBR-76



TBR-87



TBR-89



TBR-109



TBR-116



TBR-155



TBR-256



TRELLISES - NATURAL TO RUSTED TRIPOD

Approximately 58" H.

Our Tripod Trellises start out natural, with no finish and rust over time.

Degree of rust may vary at time of shipment.

Approximately 58" High.



NTR-50



NTR-127



NTR-PH

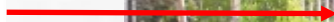

Trellis Plant Hook

Add hanging plants to your Tripod Trellises with this tension hook. Sold separately.



TRIANGLE CHIMES

Available in Small and Large.



*It's
Time For
Dinner*



TC-S
SMALL - Triangle Chime
8 ½" W. x 10" H.



TC-L
LARGE - Triangle Chime
14" W. x 15" H.



WALL HOOKS - DOUBLE HOOK

Bath Towels, Dish Towels, and even Clothes.

Measure approximately

2 ¼" W. x 2 ¾" H.

Hook Depth Measures ½" D.

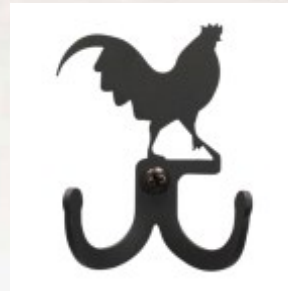

WH-D-1

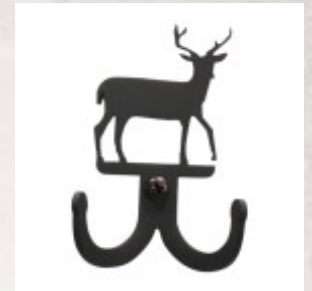

WH-D-3

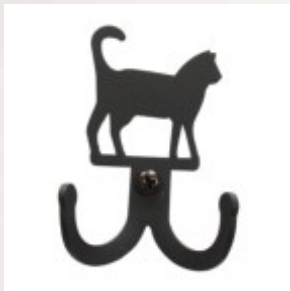

WH-D-6

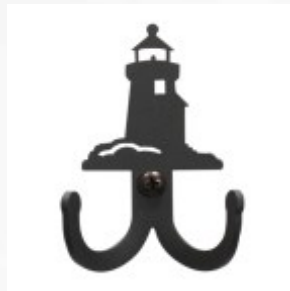

WH-D-10



WH-D-14

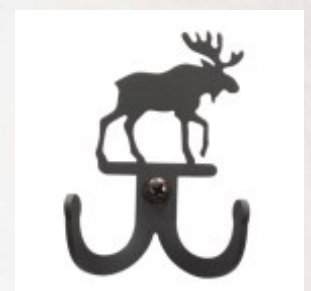

WH-D-19

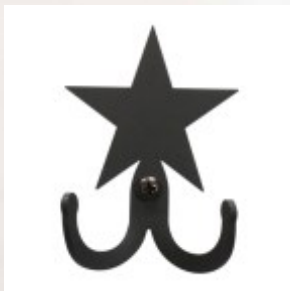

WH-D-45

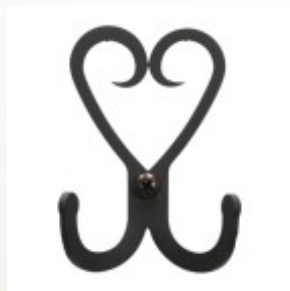

WH-D-51



WH-D-68



WH-D-87

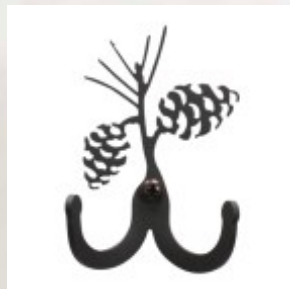

WH-D-89

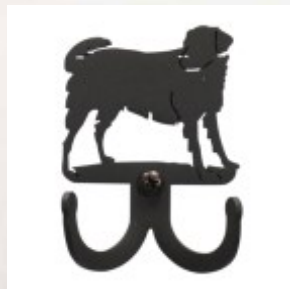

WH-D-105

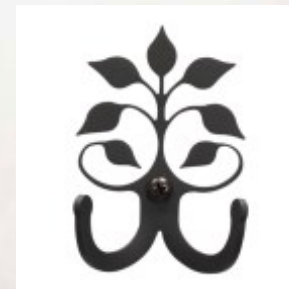

WH-D-109



WH-D-116

WALL HOOKS - EXTRA SMALL - DECORATIVE



Extra Small Wall Hooks

Measures approximately

2 ¼" H. to 4 ½" H.

Hook Depth Measures ½" D.

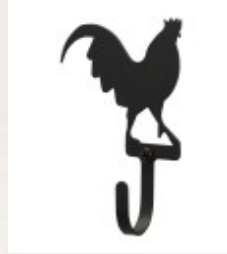

WH-1-XS



WH-3-XS

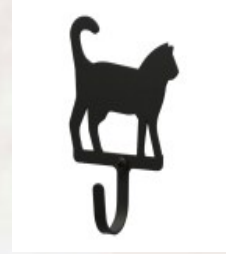

WH-6-XS



WH-10-XS



WH-11-XS

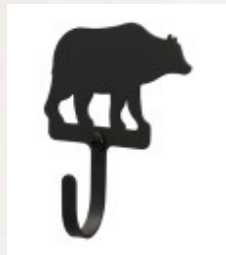

WH-14-XS



WH-18-XS



WH-19-XS



WH-38-XS

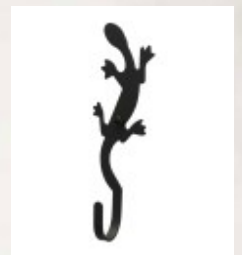

WH-39-XS



WH-40-XS



WH-42-XS



WH-45-XS



WH-50-XS



WH-51-XS

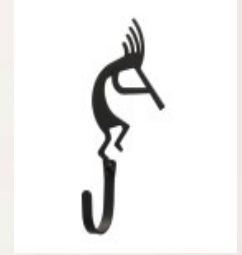

WH-56-XS

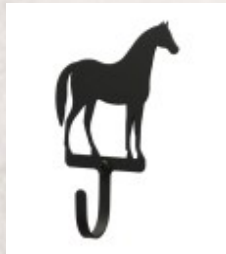

WH-68-XS



WH-70-XS



WH-76-XS



WH-89-XS



WH-93-XS

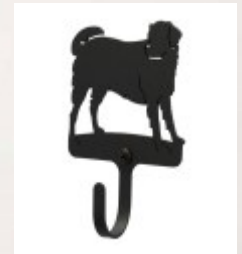

WH-105-XS



WH-109-XS



WH-116-XS



WH-119-XS



WH-121-XS



WH-173-XS



WH-186-XS



WALL HOOKS - LARGE

Measure Approximately

6" to 8 1/2" H.

Hook Depth Measures 1 1/4" D.



WALL HOOKS - MISCELLANEOUS

Ceiling - Toggle - Drive In

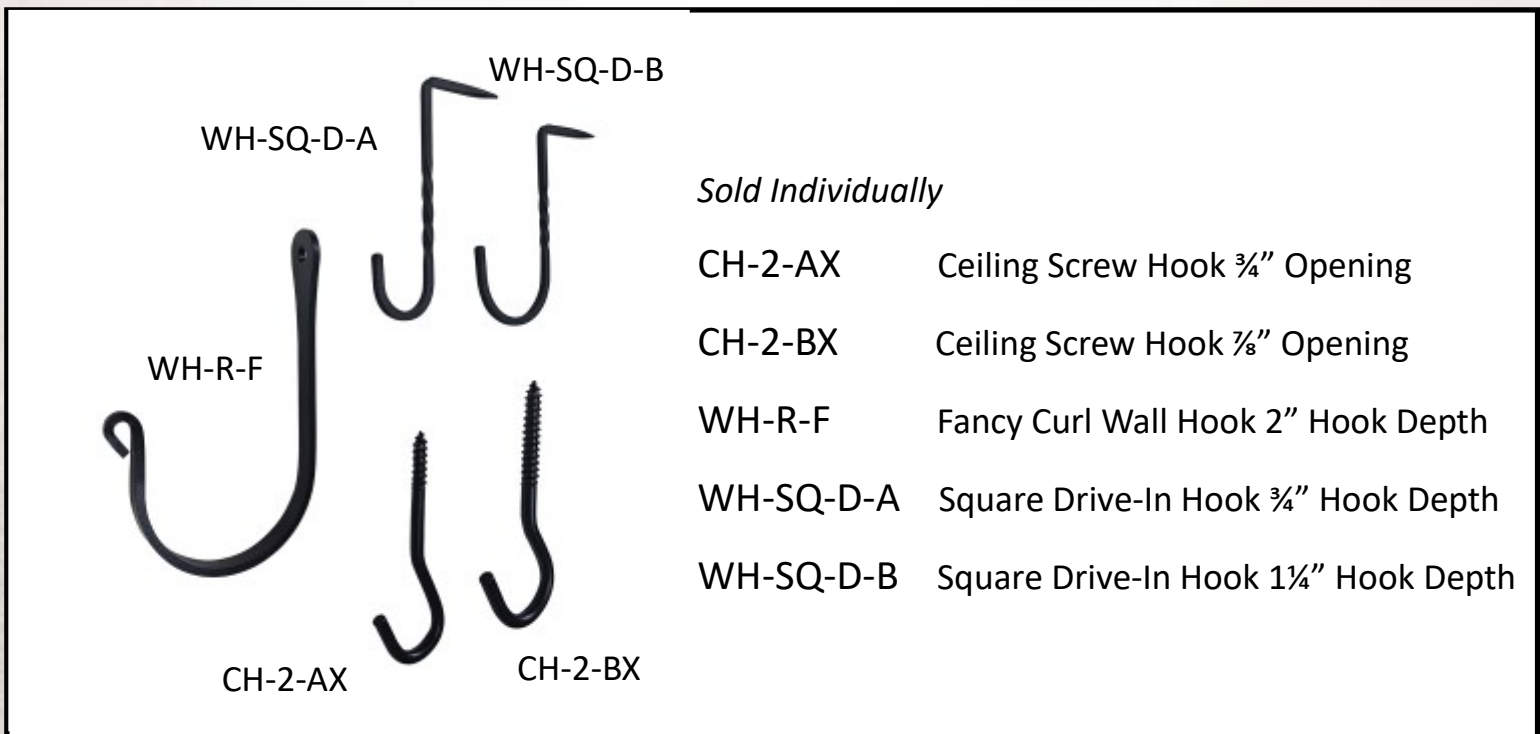
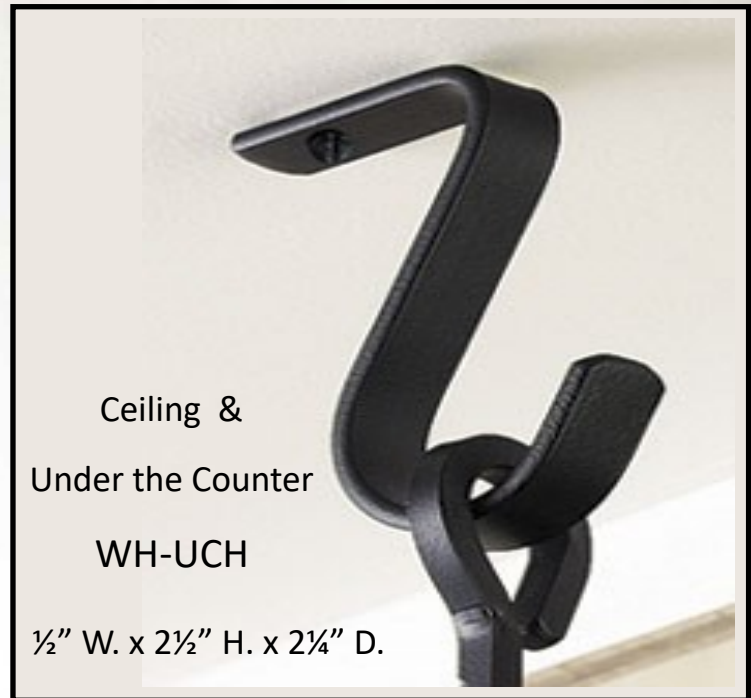
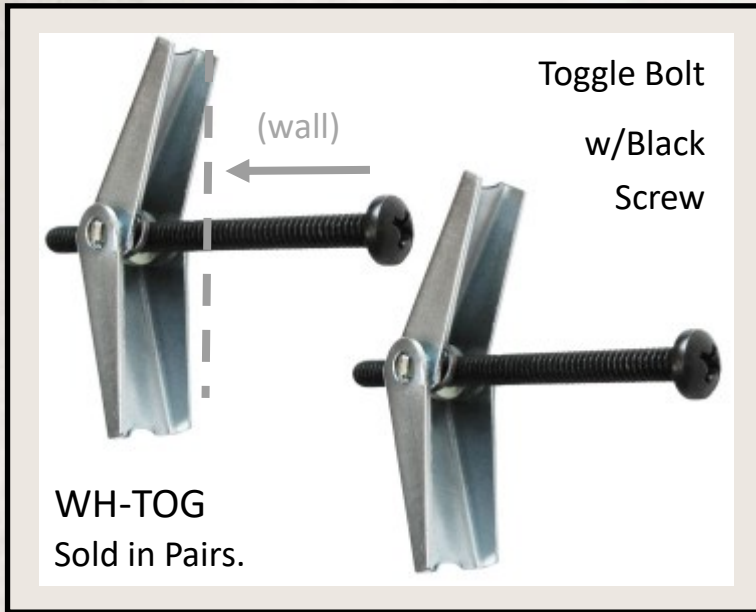



WALL HOOKS - PRIMITIVE

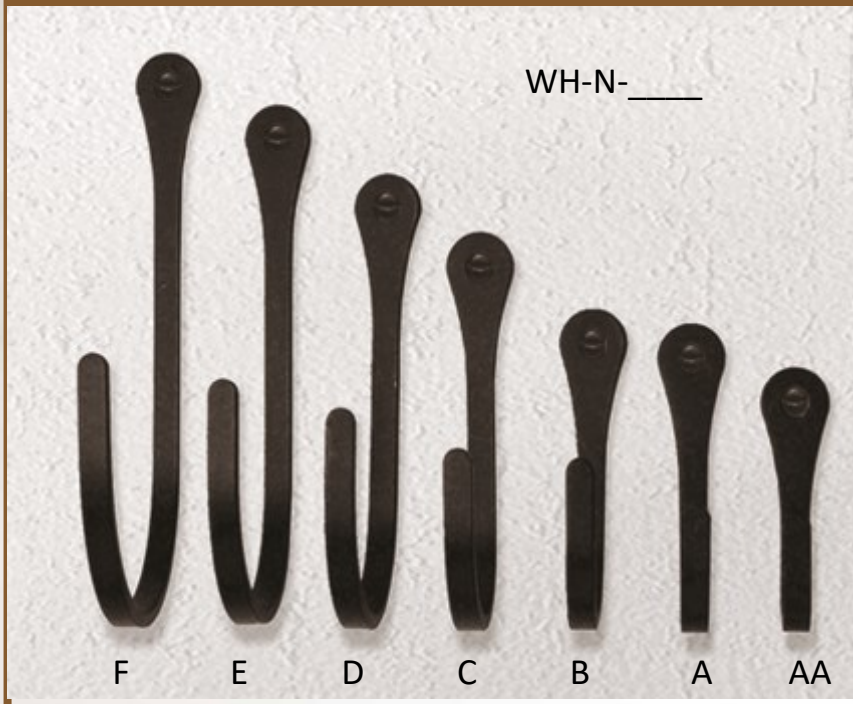

Narrow Wall Hooks

WH-N-F	2 1/8 Hook Depth
WH-N-E	1 7/8 Hook Depth
WH-N-D	1 9/16 Hook Depth
WH-N-C	1 5/16 Hook Depth
WH-N-B	1 1/8 Hook Depth
WH-N-A	13/16 Hook Depth
WH-N-AA	9/16 Hook Depth

Sold Individually

Wide Wall Hooks

WH-W-H	2 7/8 Hook Depth
WH-W-G	2 7/16 Hook Depth
WH-W-F	2 1/16 Hook Depth
WH-W-E	1 13/16 Hook Depth
WH-W-D	1 1/2 Hook Depth
WH-W-C	1 5/16 Hook Depth
WH-W-B	1 1/16 Hook Depth
WH-W-A	13/16 Hook Depth
WH-W-AA	9/16 Hook Depth

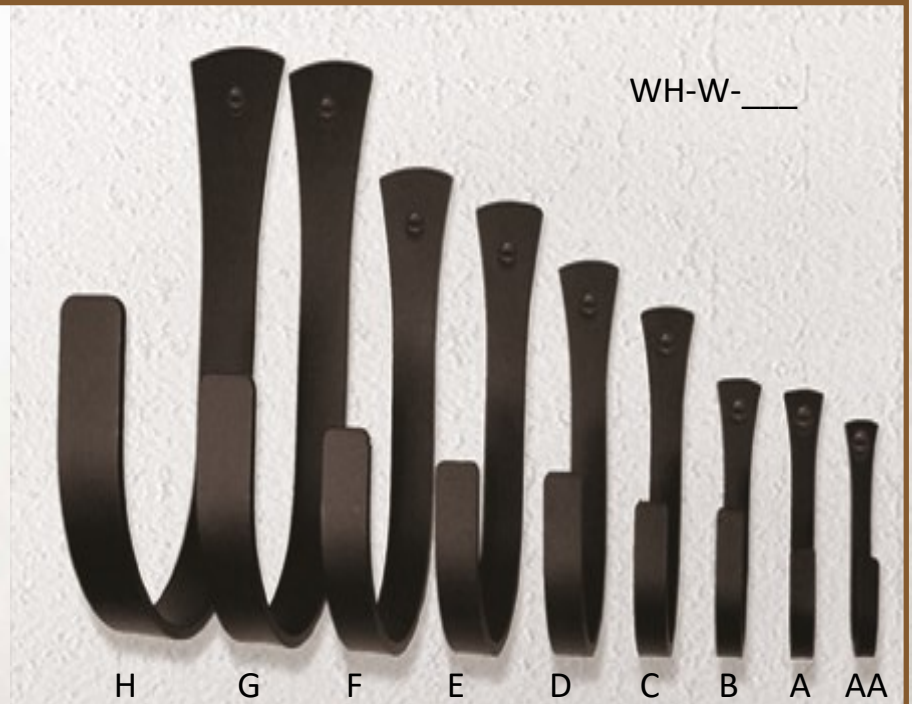

Sold Individually

WALL HOOKS - SMALL - A To Z



Measure Approximately

3 5/8" to 5" H.

Hook Depth Measures 1 1/4" D.



WH-A-S



WH-B-S



WH-C-S



WH-D-S



WH-E-S



WH-F-S



WH-G-S



WH-H-S



WH-I-S



WH-J-S



WH-K-S



WH-L-S



WH-M-S



WH-N-S



WH-O-S



WH-P-S



WH-Q-S



WH-R-S



WH-S-S



WH-T-S



WH-U-S



WH-V-S



WH-W-S



WH-X-S



WH-Y-S



WH-Z-S



WALL HOOKS - SMALL - ANIMALS

Product Code: WH-___-S

Measure approx. 3 5/8" to 5" H.
Hook Depth 1 1/4" D.

Fins, Fur, Feathers & Paws ...

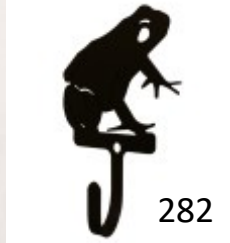
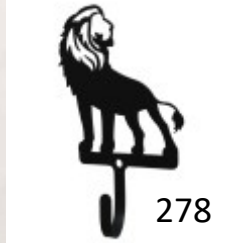
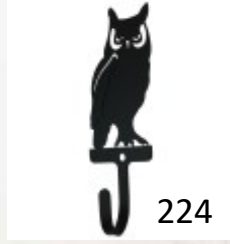
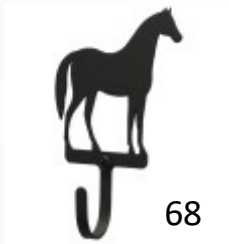
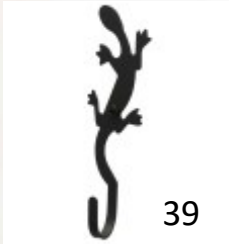

WALL HOOKS - SMALL - ANIMALS

Product Code: WH-____-S



Measure approx. 3 5/8" to 5" H.

Hook Depth 1 1/4" D.

Antlers and Tusks Too!

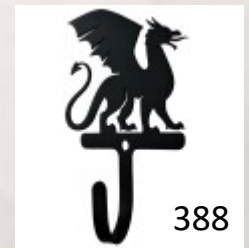
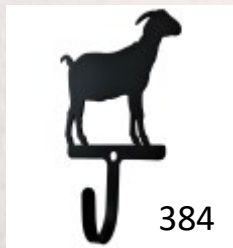
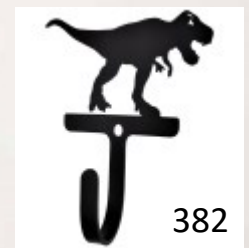
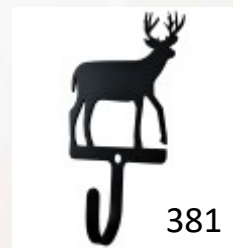
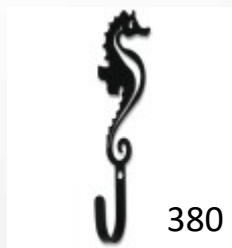
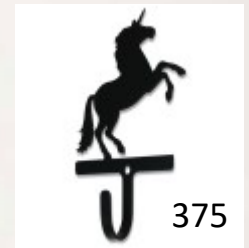
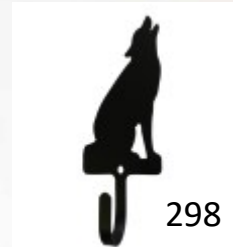
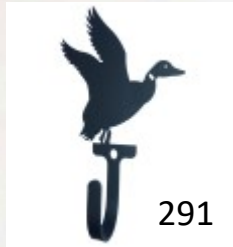



WALL HOOKS - SMALL CONSTRUCTION EQUIPMENT.

Product Code: WH-___-S

Measure Approximately

4 1/2" to 5" H.

Hook Depth Measures 1 1/4" D.

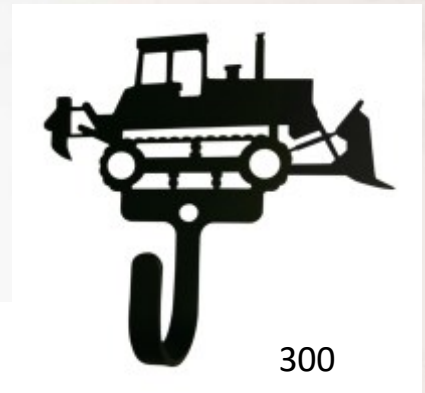

WALL HOOKS - SMALL DECORATIVE

Product Code: WH-____-S



Measure Approximately

3 5/8" to 5" H.

Hook Depth Measures 1 1/4" D.

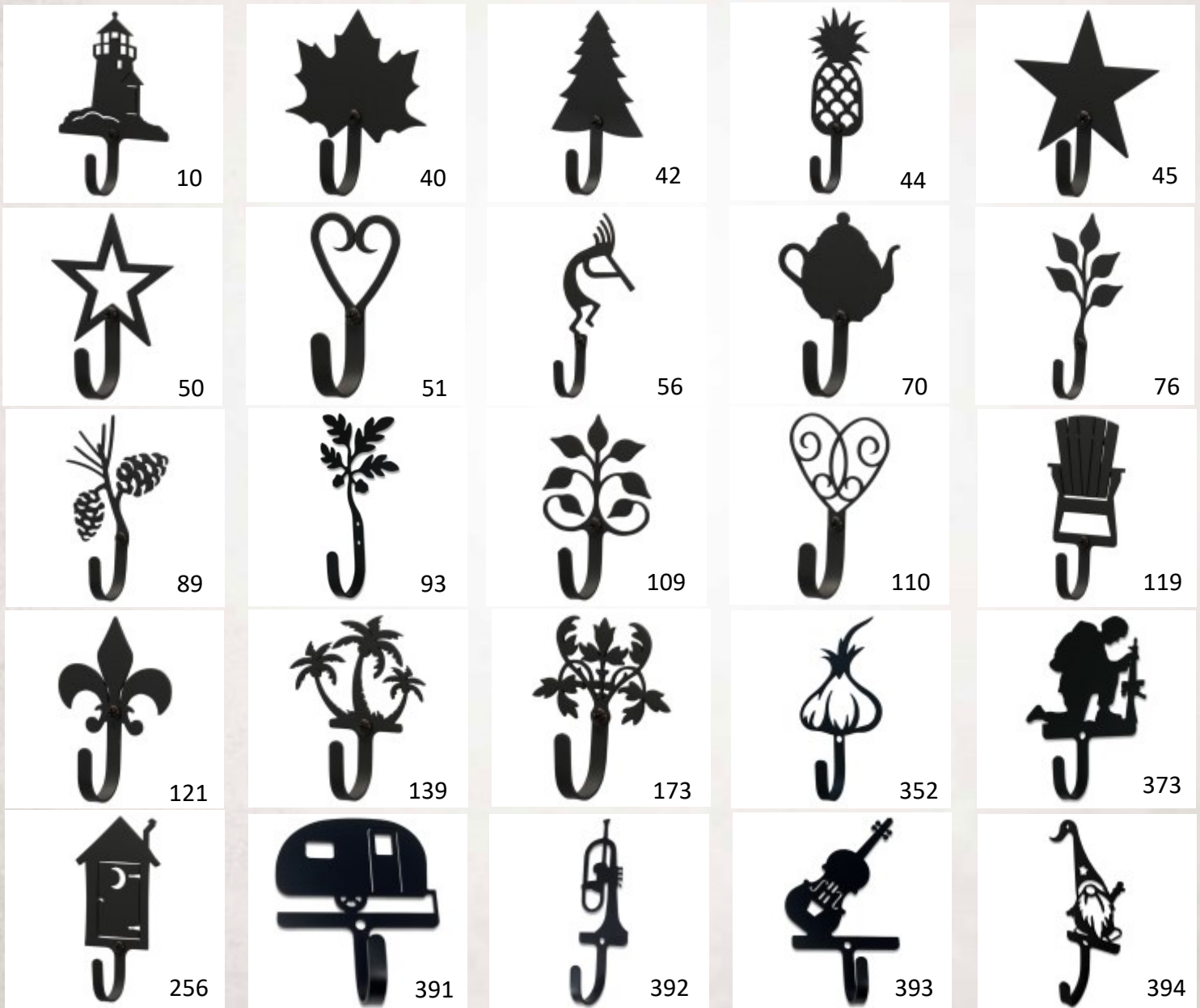



WALL HOOKS - SMALL - MAGNETIC



Measures Approximately
2 ¼" H. x 4 ½" H. Hook
Depth Measures ½" D.



WH-MAG-1



WH-MAG-6



WH-MAG-10



WH-MAG-14

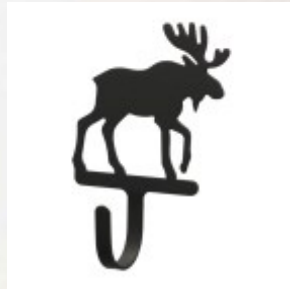

WH-MAG-19



WH-MAG-42

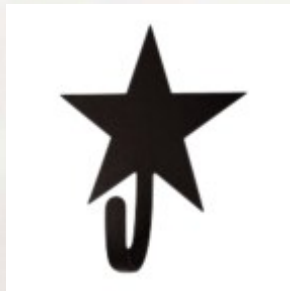

WH-MAG-45

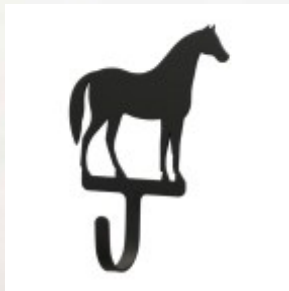

WH-MAG-68

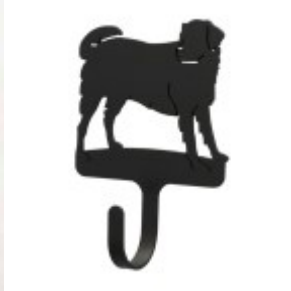

WH-MAG-105



WH-MAG-186

WALL HOOKS - SMALL - MEN'S

Product Code: WH-___-S



Measure Approximately

4 1/2" to 5" H.

Hook Depth Measures 1 1/4" D.

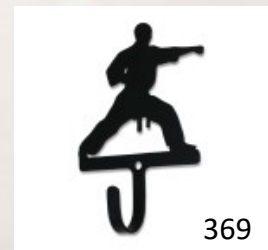
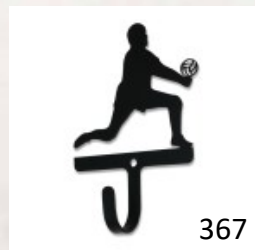
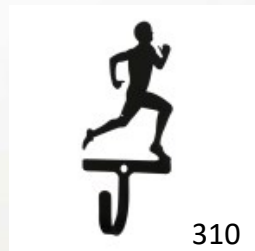



WALL HOOKS - SMALL RECREATIONAL

Bikes - Motorcycles - Jeep - Snowmobiles - Tractor - Trucks

Measure Approximately

3 5/8" to 5" H.

Hook Depth Measures 1 1/4" D.



WH-286-S



WH-301-S



WH-275-S



WH-312-S

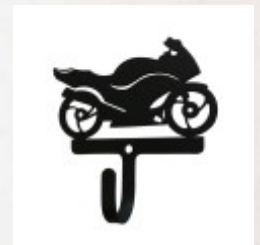

WH-318-S



WH-314-S



WH-315-S

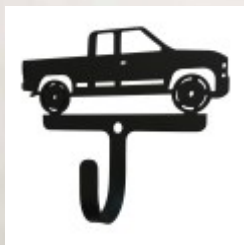

WH-319-S



WH-323-S

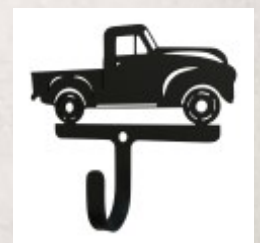

WH-325-S

WALL HOOKS - SMALL WOMAN'S

Product Code: WH-___-S



Measure Approximately

4 1/2" to 5" H.

Hook Depth Measures 1 1/4" D.



102

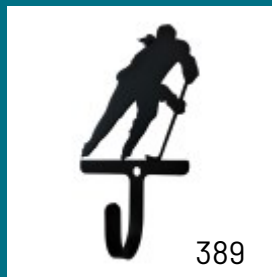

389

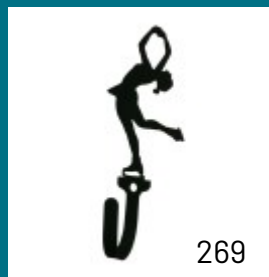

269

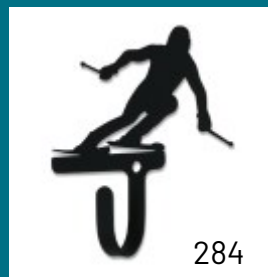

284

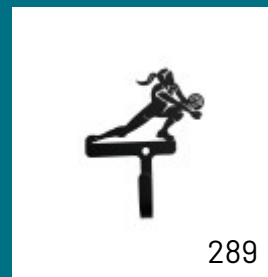

289



290

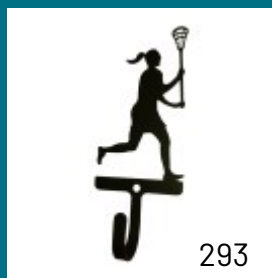

293

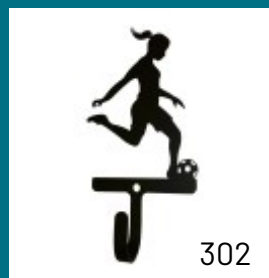

302

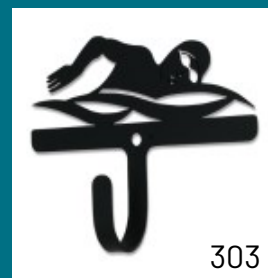

303

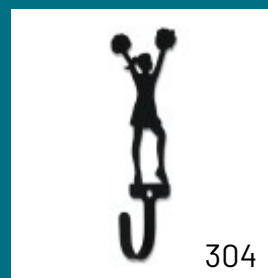

304

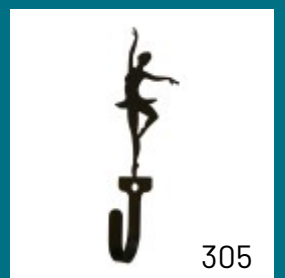

305

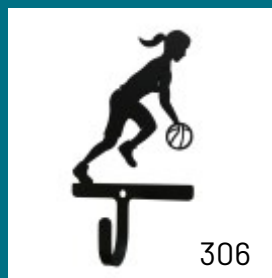

306

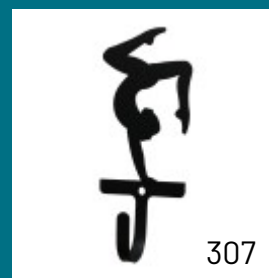

307

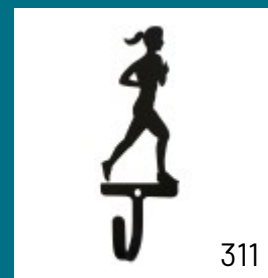

311



316

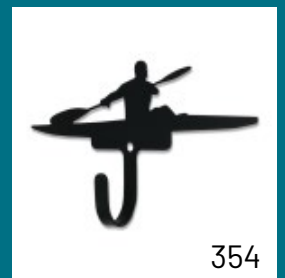

354

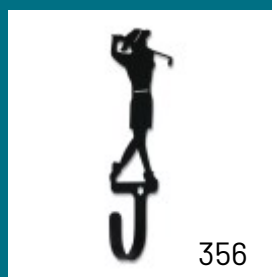

356

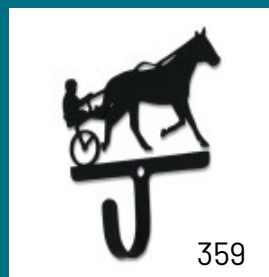

359

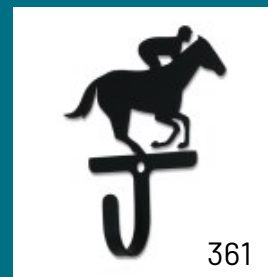

361

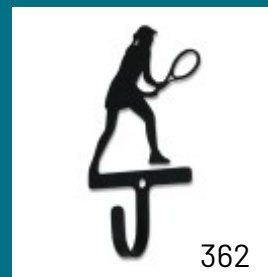

362

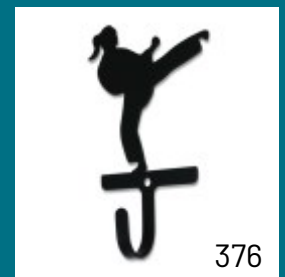

376

WELCOME SIGNS - LARGE & SMALL



WELCOME SIGNS - LARGE & SMALL



Large Welcome Sign

Measures 17 ½" W. x 12 ½" H.

Product Code: WEL-____-L



Small Welcome Sign

Measures 11 ¾" W. x 7 ⅞" H.

Product Code: WEL-____-S





WELCOME SIGNS - MEDIUM

Medium Welcome Signs

Measures Approximately 12 1/2" W. x 8 1/2" H.



WEL-164



WEL-176



WEL-177



WEL-178



WEL-185



WEL-188



WEL-190



WEL-193



WEL-232

WELCOME SIGNS - MEDIUM





WINE & GLASS CADDY

2 Glass and Wine Caddy

WRC-C-89



6 1/2" W. x 9" H. x 8" D.

Holds 1 bottle & 2 wine glasses.

WRC-C-22



WRC-C-121



WRC-C-157



Wine Bottle And Glasses

WINE & GLASS CADDY

4 Glass and Wine Caddy



9 1/2" W. x 9 1/4" H. x 6 1/2" D.

Holds 1 Bottle & 4 Wine Glasses.



Wine Bottle And Glasses
Are NOT Included.



WRC-B-157



WRC-B-121



WINE RACKS

Small - Medium - Large



WR-76-S
Small
Leaf Wine Rack



WR-157-S
Small
Grapevine Wine Rack



WR-157-M
Medium
Grapevine Wine Rack



WR-76-M
Medium Leaf Wine Rack



WR-76-L
Large Leaf Wine Rack

WINE RACKS

Small - Medium - Large



Cheers - Let's Celebrate

Wine Racks

Small

- WR-76-S Leaf Wine Rack Holds 3 Bottles
9" W. x 9½" H. x 7" D.
- WR-157-S Grapevine Wine Rack Holds 3 Bottles
9" W. x 9½" H. x 7" D.

Medium

- WR-76-M Leaf Wine Rack Holds 6 Bottles
14½" W. x 9¼" H. x 7" D.
- WR-157-M Grapevine Wine Rack Holds 5 Bottles
9" W. x 13½" H. x 7" D.

Large

- WR-76-L Leaf Wine Rack Holds 10 Bottles
14½" W. x 13¼" H. x 7" D.



Wine Bottles are NOT included.



WINE RACKS - WALL MOUNT

Grapevine Style



WR-WM-157-XXS



WR-WM-157-XS



WR-WM-157-XXS

Holds 1 Wine Bottle & 2 Glasses

7 3/4" W. x 8 1/4" H. x 3 3/4" D.



WR-WM-157-XS

Holds 2 Wine Bottles & 4 Glasses

15" W. x 13 1/8" H. x 4 1/4" D.

WINE RACKS - WALL MOUNT

Grapevine Style



WR-WM-157-S

WR-WM-157-S

Holds 3 Wine Bottles & 2 Glasses

7 ¾" W. x 15 ½" H. x 5 ¾" D.



WR-WM-157-M

WR-WM-157-M

Holds 5 Wine Bottles & 4 Glasses

8 ¼" W. x 16 ½" H. x 9" D.



WOOD RACKS



Fireplace Wood Racks

16" W. x 17 1/2" H. x 18" D.



FP-WR-89

Pine Cone Wood Rack



FP-WR-22-83

Moose and Bear Wood Rack

Moose is featured on one side,
Bear on the other side.



WREATH HANGERS

13" Long

Wreath Hangers

Measure 13" L.

Hangs flat on door.



WRE-B-45



WREATH HANGERS

13" Long



WRE-A



WRE-A-W



WRE-B-14



WRE-B-19



WRE-B-48



WRE-B-85



WRE-B-110

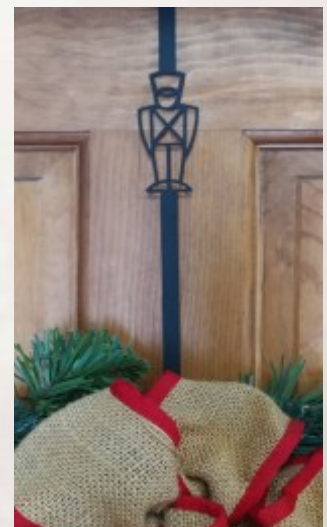

WRE-B-260

**From the heart of Central New York,
Village Wrought Iron manufactures thousands of finely crafted
wrought iron style products.**

Our family owned business started in 1975 with a goal to design and produce decorative - functional long lasting handcrafted products for your home and garden. All our products are carefully handmade using the finest materials and time tested methods of craftsmanship.

Quality and durability are our priorities.

All our powder coated products have an exceptional long-lasting black baked-on powder coated finish (unless otherwise indicated) that will last for years.

On In Stock Items,
Orders Ship Within 1 to 3 Business Days.
Prices And Ordering Are Done Through Our Website.

Warehouse Hours

Eastern Standard Time

Sun: Closed

Mon: 8:30am - 4:30pm

Tues: 8:30am - 4:30pm

Wed: 8:30am - 4:30pm

Thurs: 8:30am - 4:30pm

Fri: 8:00am - 11:00am

Sat: Closed

Village Wrought Iron Inc.

7756 Main Street
Fabius, NY 13063



Tel: +1 (315) 683-5589 ext. 14

Fax: +1 (315) 683-5598



cs@VillageWroughtIron.com

shipping@VillageWroughtIron.com

VillageWroughtIron.com