

Village  
Wrought  
Iron Inc.™

# VILLAGE WROUGHT IRON

Wrought Ironwork Manufacturing

*All products are made in Central New York, using only high-quality, lead free, domestic materials.*

2024 **RETAIL** PRODUCT CATALOG



VOLUME 49, ISSUE NO. 5

# CONTENTS

<b>PAGE</b>	<b>TITLE</b>	<b>PAGE</b>	<b>TITLE</b>
1	Cover	60	Plaques - A-Z -Over The Door
2	Table of Contents	61	Plaques - Over The Door
3	Bookends	62	Recycle Bins & Magazine Stands
4	Candleware - Pillar candle Holder - Fireplace	63	S - Hooks
5	Candleware – Pillar Candle Holder – Table Top	64	S - Hooks
6	Candleware – Pillar Candle Holder – Table Top	65	S - Chains
7	Collar & Leash Holder - Dog & Cat	66	S - Hooks Decorative
8	Collar & Leash Holder - Dog & Cat	67	Shelf Brackets
9	Cat & Dog - Key Holders	68	Shelf Brackets
10	Cat & Dog - Key Holders	69	Shelf Brackets - Extra Heavy
11	Cat & Dog - Wall Hooks	70	Shelf Brackets - Extra Heavy
12	Cat & Dog - Welcome Signs	71	Sign Brackets
13	Coat Bars – CUSTOM	72	Sign Brackets
14	Coat Bars – Decorative	73	Silhouettes - Hanging
15	Cup Racks	74	Silhouettes - Hanging
16	Curtain - Cranes	75	School FUNDRAISING—NEW
17	Curtain - Rods	76	Snow Gauges
18	Curtain - Brackets Included with OUR Curtain Rods	77	Sports - Men - Key Holders
19	Curtain - Brackets For OUR Curtain 1/2 In. Rods	78	Sports - Men - Wall Hooks
20	Curtain - Rings For OUR Curtain Rods	79	Sports - Women - Wall Hooks
21	Curtain - Shelf Brackets Fits OUR 1/2 In. Rods	80	The Outhouse - Home Decor
22	Curtain - Shelf Brackets Fits OUR 1/2 In. Rods	81	Toilet Tissue Holders -Roller Style
23	Curtain - Tie Backs	82	Toilet Tissue Holders - Traditional
24	Curtain - Tie Backs	83	Towel Bars
25	Electrical - Switch & Outlet Covers	84	Towel Holders - Ring Style
26	Electrical - Switch & Outlet Covers	85	Trellises - Natural to Rusted Tripod
27	Electrical - Understand Our Codes	86	Triangle Dinner Chimes
28	Electrical - Switch & Outlet Covers - CUSTOM	87	Wall Hooks - DOUBLE HOOK
29	Garden - Hose Holders & Guides	88	Wall Hooks - EXTRA SMALL
30	Garden - Stakes – Trellises - Natural to Rusted Tripod	89	Wall Hooks - LARGE
31	Garden - Stakes – Natural To Rusted	90	Wall Hooks - Miscellaneous
32	Garden - Stakes – Natural To Rusted	91	Wall Hooks - Narrow & Wide Primitive
33	Hair Care Caddy	92	Wall Hooks - SMALL A-Z
34	Hair Care Caddy	93	Wall Hooks - SMALL Animals
35	Hardware – Cabinet Door Handles & Knobs	94	Wall Hooks - SMALL Animals
36	Hardware – Cabinet Door Handles & Knobs	95	Wall Hooks - SMALL Equipment
37	House Letters & Numbers	96	Wall Hooks - SMALL
38	House Letters & Numbers	97	Wall Hooks - SMALL - Magnetic
39	House Plaques – CUSTOM	98	Wall Hooks - SMALL Men
40	House Plaques – CUSTOM	99	Wall Hooks - SMALL Motorized Vehicles
41	Key Chains	100	Wall Hooks - SMALL Women
42	Key Holders	101	Welcome Signs - SMALL & LARGE
43	Key Holders	102	Welcome Signs - SMALL & LARGE
44	Key Holders	103	Welcome Signs - MEDIUM
45	Key Holders - Cats & Dogs	104	Welcome Signs - MEDIUM
46	Key Holders - Sports	105	Wine - Rack & 2 Glass Caddy
47	Mantle Hooks	106	Wine - Rack & 4 Glass Caddy
48	Mitten & Boot Drying Stands	107	Wine - Rack & Stands
49	Napkin Holders	108	Wine - Rack & Stands
50	Napkin Holders	109	Wine - Racks - Wall Mount
51	Napkin Rings	110	Wine - Racks - Wall Mount
52	Organize	111	Wood Racks
53	Paper Towel Holders - Wall Mount	112	Wood Racks
54	Paper Towel Holders - Wall Mount	113	Wreath Hangers
55	Paper Towel Holders - Counter Top	114	Wreath Hangers
56	Recipe Card Holder	115	Back Cover
57	Plant Hangers - Flat Iron		
58	Plant Hangers - Removable		
59	Plant Hangers - Square Iron		

# BOOKENDS

Measure 5" W. x 6 ¼" H. x 3 ½" D.



# CANDLE HOLDERS - PILLAR

28" W. x 8 1/2" H. x 8" D. Holds 3" Diameter Pillar Candles  
*(Candles Not Included)*



C-PFP-45



C-PFP-22-83



C-PFP-173



C-PFP-89



# CANDLE HOLDERS - PILLAR

18 1/2"W. x 5 1/4"H. x 5"D.

Holds 2" Diameter Pillar Candles.

*(Candles Not Included)*



# CANDLE HOLDERS - PILLAR

18 1/2"W. x 5 1/4"H. x 5"D.

Holds 2" Diameter Pillar Candles.

*(Candles Not Included)*





# CAT & DOG - COLLAR / LEASH HOLDERS

Sizes Range From: 4"W. x 4"H. To 4"W. x 6 1/4"H.

Product Code: WH-LC-\_\_\_\_

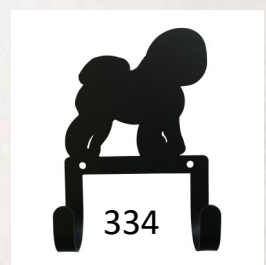

# CAT & DOG - COLLAR / LEASH HOLDERS

Sizes Range From: 4"W. x 4"H. To 4"W. x 6 1/4"H.

Product Code: WH-LC-\_\_\_\_

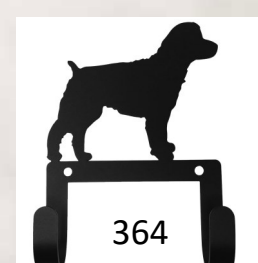
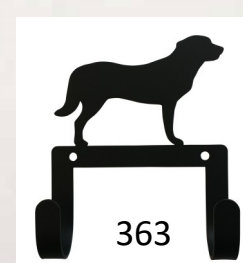
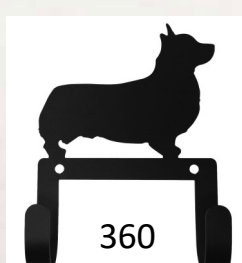
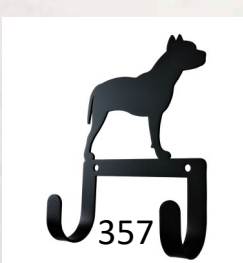
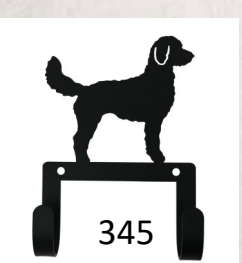
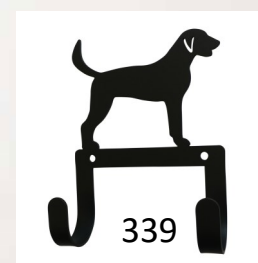
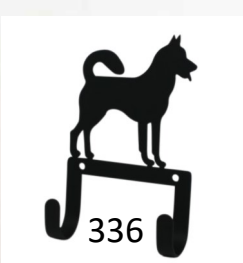
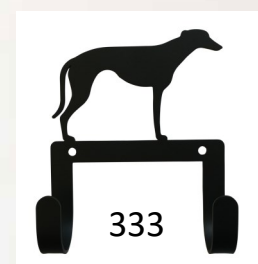
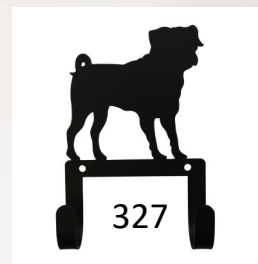
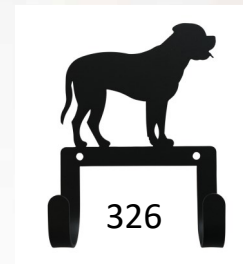
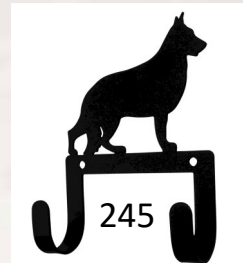



## CAT & DOG - KEY HOLDERS

Sizes Range From 7 ¼" W. x 4" H. To 7 ¼" W. x 8" H.



KH-105



KH-245



KH-236

# CAT & DOG - KEY HOLDERS

Sizes Range From 7 ¼" W. x 4" H. To 7 ¼" W. x 8" H.



KH-237



KH-240



KH-241



KH-242



KH-243



KH-244



KH-6



KH-246



KH-247

# CAT & DOG - WALL HOOKS - SMALL

Measure approx. 3 5/8" to 5" H. Hook Depth 1 1/4" D.

Product Code: WH-\_\_\_-S



6



105



236



237



239



240



241



242



243



244



245



246



247



321



324



326



327



328



329



333



335



345



357



360



364

# CAT & DOG - WELCOME SIGNS

Measure 11 3/8" W. x 7 7/8" H.



WEL-105-S

WEL-236-S

WEL-237-S

WEL-240-S



WEL-241-S

WEL-242-S

WEL-243-S

WEL-244-S



WEL-245-S

WEL-6-S

WEL-246-S

WEL-247-S



# CUSTOMIZED COAT BARS

House Warming, Wedding , Birthday Or Any Gift.  
*(Please allow 4 weeks for delivery.)*



## Customized **5** Hook Coat Bars

Up to 18 Characters

29 1/2" W. x 7 1/2" H. x 2 1/2" D.

**Product Code: CB-CUS-5**

## Customized **3** Hook Coat Bars

Up to 9 Characters

16" W. x 7 1/2" H. x 2 1/2" D.

**Product Code: CB-CUS-3**

When ordering online,  
please specify characters that you would like on the Cost Bar in the special instruction box during checkout.  
Spaces count as 1 character



**Single** Coat Hook

May Be Purchased Separately

1/2" W. x 6 1/2" H. x 3 1/4" D.

**Product Code: CT-WH-1**

# DECORATIVE COAT BARS

These Coat Bars Will Hold 4 To 8 Coats.



## 4 Hook Decorative Coat Bars

Easily Holds 8 Coats.

24" W. x 8½" H. x 2½" D.

Each Hook Measures

½" W. x 5 ½" H. x 2 ½" D.



CB-3



CB-20



CB-22



CB-44



CB-68



CB-83



CB-87

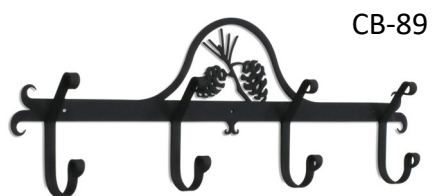

CB-89



CB-109



CB-116



CB-119

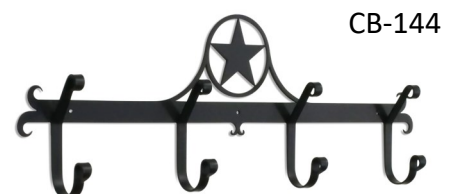

CB-144



# CUP - POT - UTENSIL RACK

Extremely Versatile And Extra Hooks Are Available.

**CR-16**  
Wall Mount 16" L.  
4 Movable Hooks.



**CR-24**  
Wall Mount 24" L.  
6 Movable Hooks.



**CR-EXH** Additional Hooks May Be Purchased Separately



# CURTAIN CRANE SETS

Includes 2 Cranes And Mounting Brackets



24" Crane Set  
CUR-CRN-24

18" Crane Set  
CUR-CRN-18

12" Crane Set  
CUR-CRN-12

Includes 2 cranes and  
mounting brackets.





# CURTAIN RODS

Curtain Brackets Included With Our 1/2" Curtain Rod Sets.

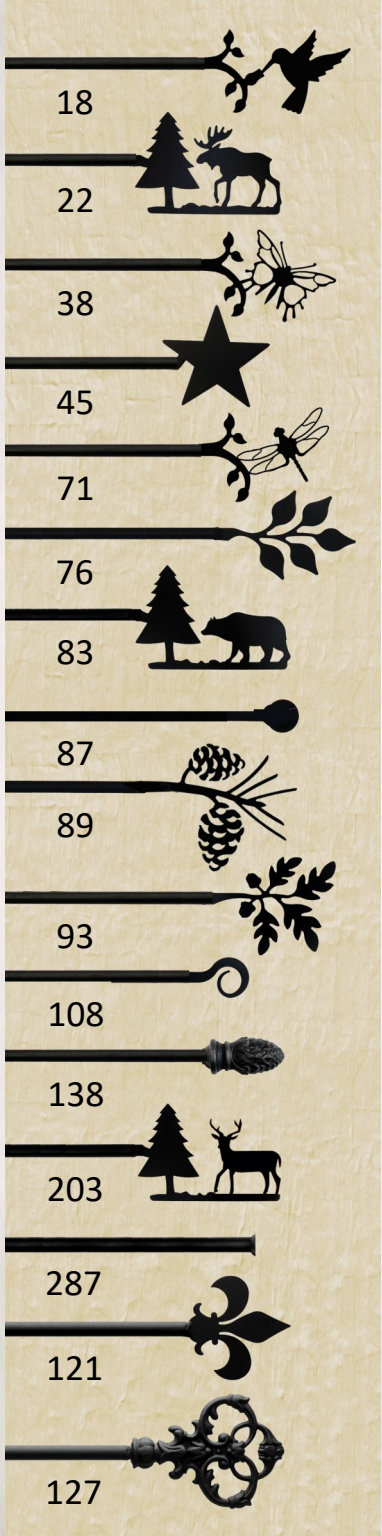

Curtain Rods Extending 21" to 35"  
DO NOT Include A Center Support Bracket



- CUR-\_\_\_-35-S      21" - 35"
- CUR-\_\_\_-60-S      36" - 60"
- CUR-\_\_\_-112-S     61" - 112"
- CUR-\_\_\_-130-S     113" - 130"

All Other Curtain Rods Include  
A Pair Of Brackets AND Center Support



# CURTAIN BRACKETS

Included With Our Curtain Rods.



Measurements For Curtain Brackets And Center Bracket

## That Are Included With Our Curtain Rods.

Center Brackets Are Included With ALL Rods except Our Smallest Rods Extending From 21 to 35".

*(Not for purchase)*

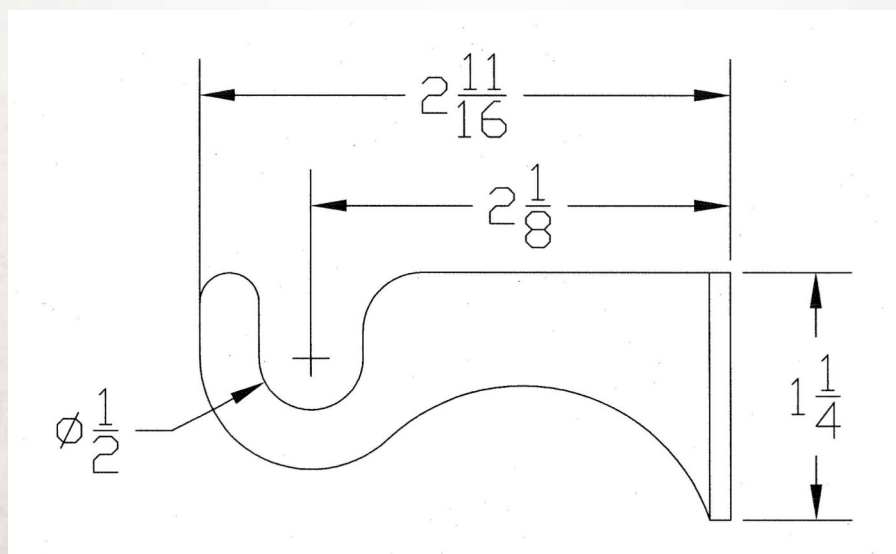
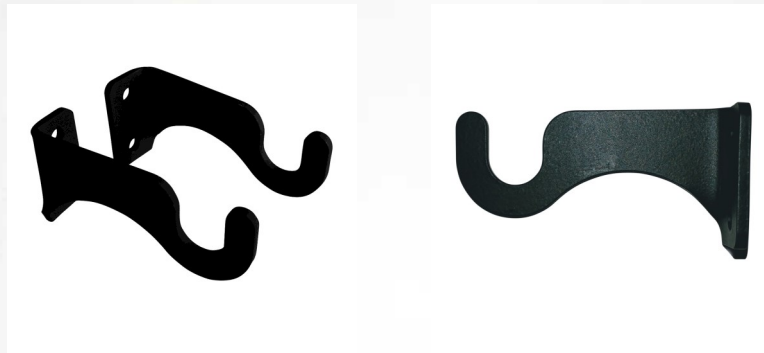



# CURTAIN BRACKETS - More

All Of The Brackets Shown On This Page  
Fits Our 1/2" Curtain Rods.

The Double / Triple Curtain Bracket Pair  
Holds 2 or 3 Curtain Rods.  
Perfect For Layering Window Treatments.



EXTRA SMALL Curtain Bracket Pair 1 3/4" Depth CUR-BRAC-XS	REGULAR Curtain Bracket Pair 3 1/8" Depth CUR-BRAC	DOUBLE Curtain Bracket Pair 3 3/8" Depth CUR-BRAC-DB	DOUBLE/TRIPLE Curtain Bracket Pair 4 1/2" Depth CUR-BRAC-DT
--	---	---	--



EXTRA SMALL Curtain Bracket Center Support 1 3/4" Depth CUR-BRAC-XS-C	REGULAR Curtain Bracket Center Support 3 1/8" Depth CUR-BRAC-C	DOUBLE Curtain Bracket Center Support 3 3/8" Depth CUR-BRAC-DB-C	DOUBLE/TRIPLE Curtain Bracket Center Support 4 1/2" Depth CUR-BRAC-DT-C
---	--	--	---

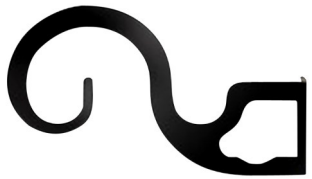

# CURTAIN RINGS

That Fit Our ½" Curtain Rods.



**Curtain Clip Rings Come In A Set Of 7**

1 ¼" W. x 2 ½" H.

**CUR-RNG**





# CURTAIN SHELF BRACKETS

That Fit Our Curtain Rods.



# CURTAIN SHELF BRACKETS

Showcase Any Window With Our Curtain Shelf Brackets



**Curtain Shelf Brackets Sold In Pairs**

**Wood And Curtain Rod NOT Included**

Measure Approximately 4 3/4" W. x 7 1/2" H. x 5 1/2" D.

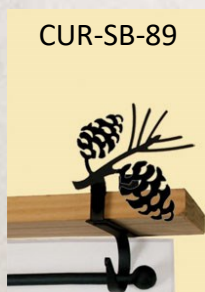
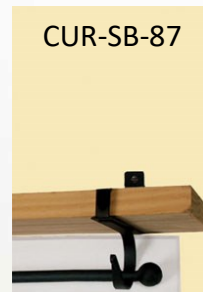
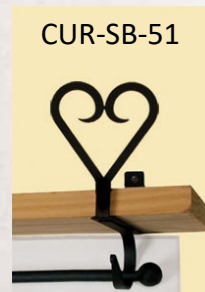
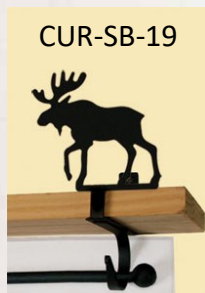
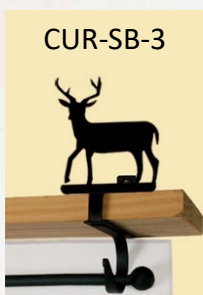

A Center Support Is Recommended For Use With Curtain Rods 61" Or Longer, And Is Sold Individually.



## CURTAIN TIE BACKS

Silhouette Shapes Range From  
 $\frac{1}{2}$ " W. x 2" H. To 3" W. x 8  $\frac{1}{4}$ " H.



# CURTAIN TIE BACKS

Silhouette Shapes Range From  
1/2" W. x 2" H. To 3" W. x 8 1/4" H.

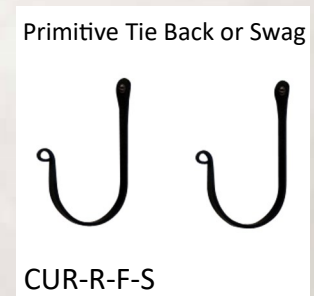
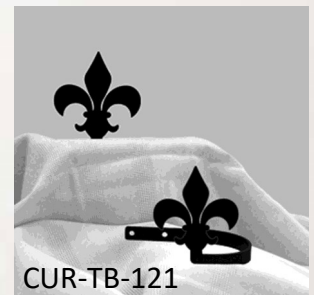
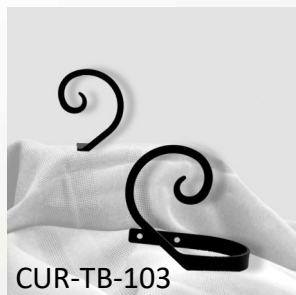
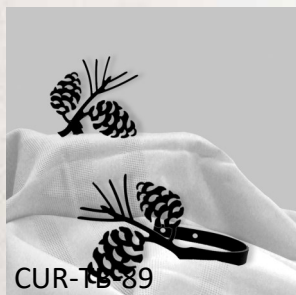
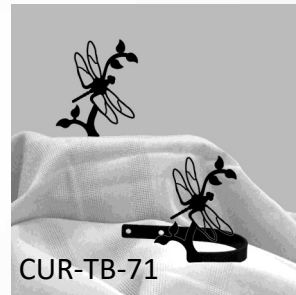
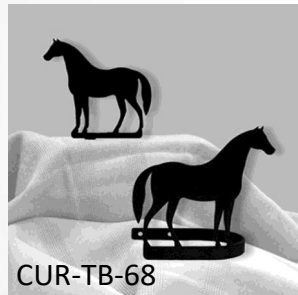
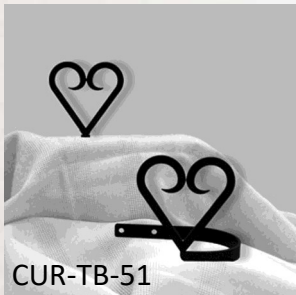
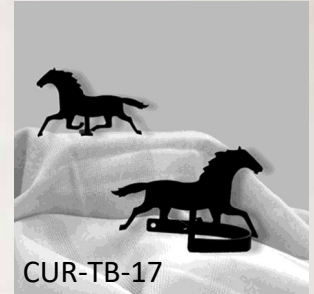
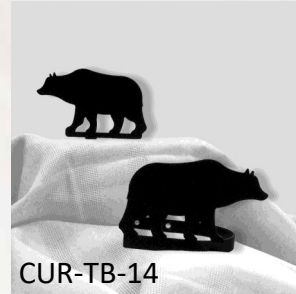
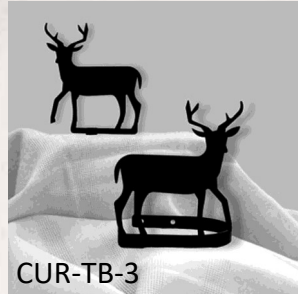





# ELECTRICAL COVERS Silhouettes Available

Decorative Switch Plates & Outlet Covers.

## Decorative Switch Plate & Outlet Covers

All Silhouettes Are Centered On Plate Covers.

On These Pages Are The Silhouette Numbers Listed For Ordering.



256



1

3

6

10

14

19

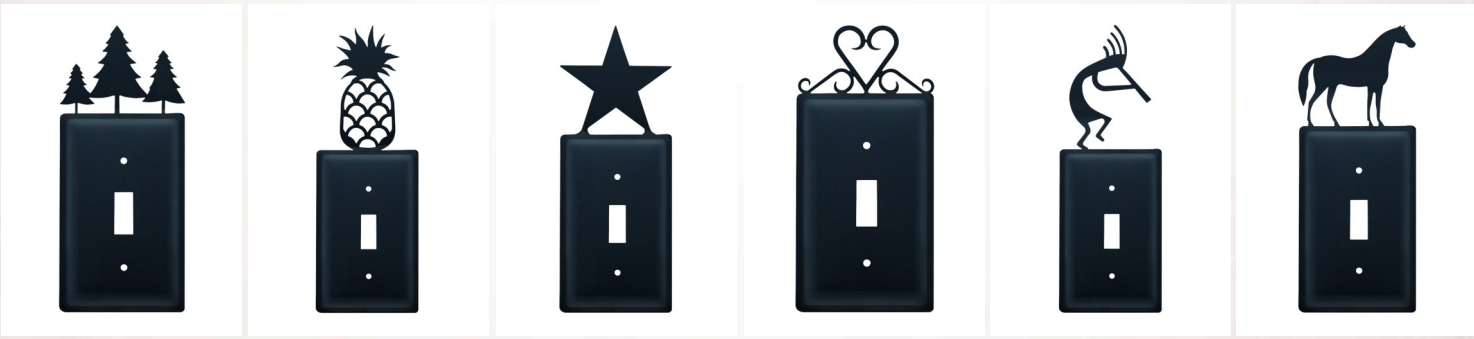

20

44

45

51

51

68



87

89

109

116

119

133

# ELECTRICAL COVERS - Stock Covers

Decorative Switch Plates & Outlet Covers



## Decorative Switch Plate & Outlet Covers

On This Page Are The Covers We Keep In Stock  
In All The Various Silhouettes Shown On Page 24.



EO-\_\_



ES-\_\_



ESS-\_\_



ESSS-\_\_



ESSSS-\_\_



EOS-\_\_



EEO-\_\_



EG-\_\_



EGG-\_\_

Understanding Our Electrical Product Codes



**C**  
Stands For  
Cover

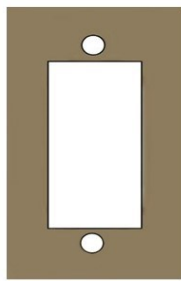

**G**  
Stands For  
GFI

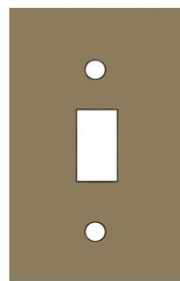

**S**  
Stands For  
Switch

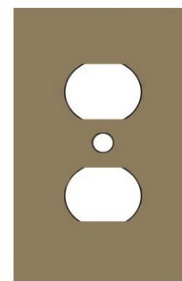

**O**  
Stands For  
Outlet

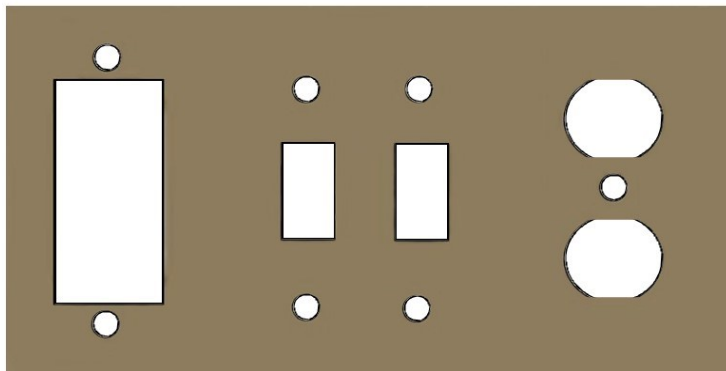

All our electrical covers begin with the product code E.

The going from left to right the codes describe what openings are featured on the cover.

The above example is EGSSO

# ELECTRICAL COVERS - Custom



## Combination Covers



EC-\_\_



ECC-\_\_

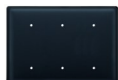

ECCC-\_\_



ECCCC-\_\_



EGGG-\_\_



EGGGG-\_\_



E000-\_\_



E0000-\_\_



ESSS-\_\_



ESSSS-\_\_

## Mixed Combo Covers

### Starting With EG



EGO-\_\_



EGS-\_\_



EGGS-\_\_



EGOG-\_\_



EGSG-\_\_



EGSO-\_\_



EGSS-\_\_



EGGSS-\_\_



EGSSO-\_\_



EGSSS-\_\_

## Mixed Combo Covers

### Starting With EO



EOG-\_\_



EOGG-\_\_



EOOG-\_\_



EOOS-\_\_



EOS-\_\_



EOSS-\_\_



EOGG-\_\_



EOOSS-\_\_



EOSSS-\_\_

## Mixed Combo Covers

### Starting With ES



ESG-\_\_



ESO-\_\_



ESGO-\_\_



ESOG-\_\_



ESSG-\_\_



ESSO-\_\_



ESSSG-\_\_



ESSSO-\_\_

Our CUSTOM Covers Are  
Made When Ordered, In All  
The Various Silhouettes  
Shown On Page 26.

# GARDEN - HOSE HOLDERS & GUIDES

This Year, Let's Keep Your Hoses Where You Want Them.



**HH-SQ-LB**  
½" Square Hose Holder 54" High  
Holds Up To 200' Garden Hose



**HH-WM**  
Wall Mount Hose Holder  
8" High  
Holds Up To 100' Garden Hose

**HG-127**  
Decorative Hose Guide  
Measures 17" High



# TRELLISES - NATURAL TO RUSTED TRIPOD

Approximately 58" H.



Our Tripod Trellises start out natural, with no finish and rust over time.

Degree of rust may vary at time of shipment.

Approximately 58" High.

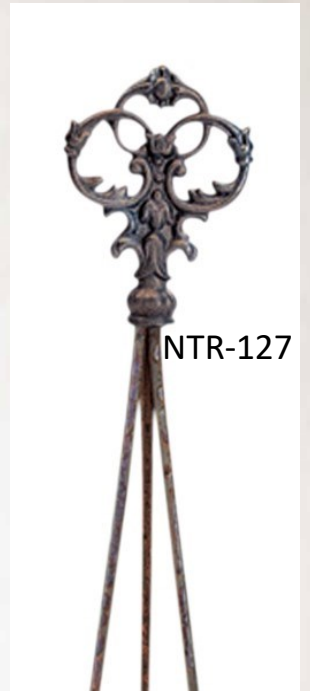

NTR-PH



## Trellis Plant Hook

Add hanging plants to your Tripod Trellises with this tension hook. Sold separately.



# GARDEN - RUSTED DECORATIVE STAKES

Approximately 35" Tall.

## Rusted Garden Stakes

Approximately 35" Tall



Naturally Rusted Surfaces May Vary.

This Is A  
Sample Of The Color.



RGS-250



RGS-267



RGS-273



RGS-374-S

# GARDEN - RUSTED DECORATIVE STAKES

Photos Are A Close Up, And Do Not Include The Entire Stake.

Village  
Wrought  
Iron Inc.

TM



RGS-1



RGS-2



RGS-3



RGS-9



RGS-14



RGS-16



RGS-19



RGS-25



RGS-26



RGS-28



RGS-29



RGS-30



RGS-33



RGS-34



RGS-37



RGS-39



RGS-45



RGS-46



RGS-48



RGS-53



RGS-56



RGS-59



RGS-62



RGS-64



RGS-67



RGS-68



RGS-72-B



RGS-73



RGS-75



RGS-80



RGS-84



RGS-95



RGS-96



RGS-97



RGS-98



RGS-99





## HAIR DRYER / CADDY

Holds Curling Iron & Straighteners Too  
Measures 11" W. x 5" H. x 4" D.

Keep Hair Styling Accessories Handy!

Measures 11" W. x 5" H. x 4" D.



# HAIR DRYER / CADDY

Holds Curling Iron & Straighteners Too  
Measures 11" W. x 5" H. x 4" D.



HD-10



HD-19



HD-14



HD-38



HD-45



HD-68



HD-71



HD-89



HD-109



HD-155



HD-121



HD-173



HD-256



# HARDWARE - HANDLES & KNOBS

Cabinet Door Handles and Knobs.



Choose From Our Door Knobs, Handles  
(Vertical Or Horizontal)  
OR Just Purchase The Silhouettes!  
Silhouettes May Be Used Facing Left Or Right  
To Customize Your Cabinet Hardware.

Cabinet Door Silhouettes ONLY.

**Dress Up Your Existing Cabinet Hardware.**

Silhouettes Measure Approx. 1 1/2" W. x 2" H.



DHK- 1

DHK- 10

DHK- 14

DHK- 19

DHK- 42

DHK- 45

DHK- 68

DHK- 109

DHK- 153

# HARDWARE - HANDLES & KNOBS

Cabinet Door Handles and Knobs.



Product Code: DKP- \_\_\_\_



Product Code: DHP-A- \_\_\_\_



Product Code: DHP-B- \_\_\_\_



Pick The Style Of

Cabinet Door Knob Or Handle...

DKP- \_\_\_\_

DHP-A- \_\_\_\_

DHP-B- \_\_\_\_

Then The Silhouette Number From Below

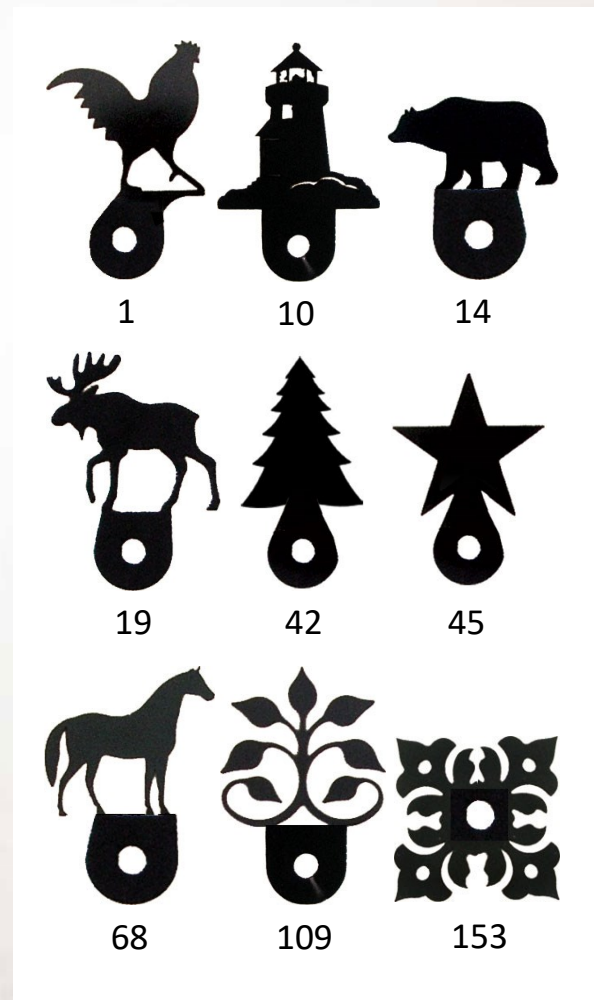



# HOUSE LETTERS AND NUMBERS

For Business and Residential Use.

Letters and Numbers

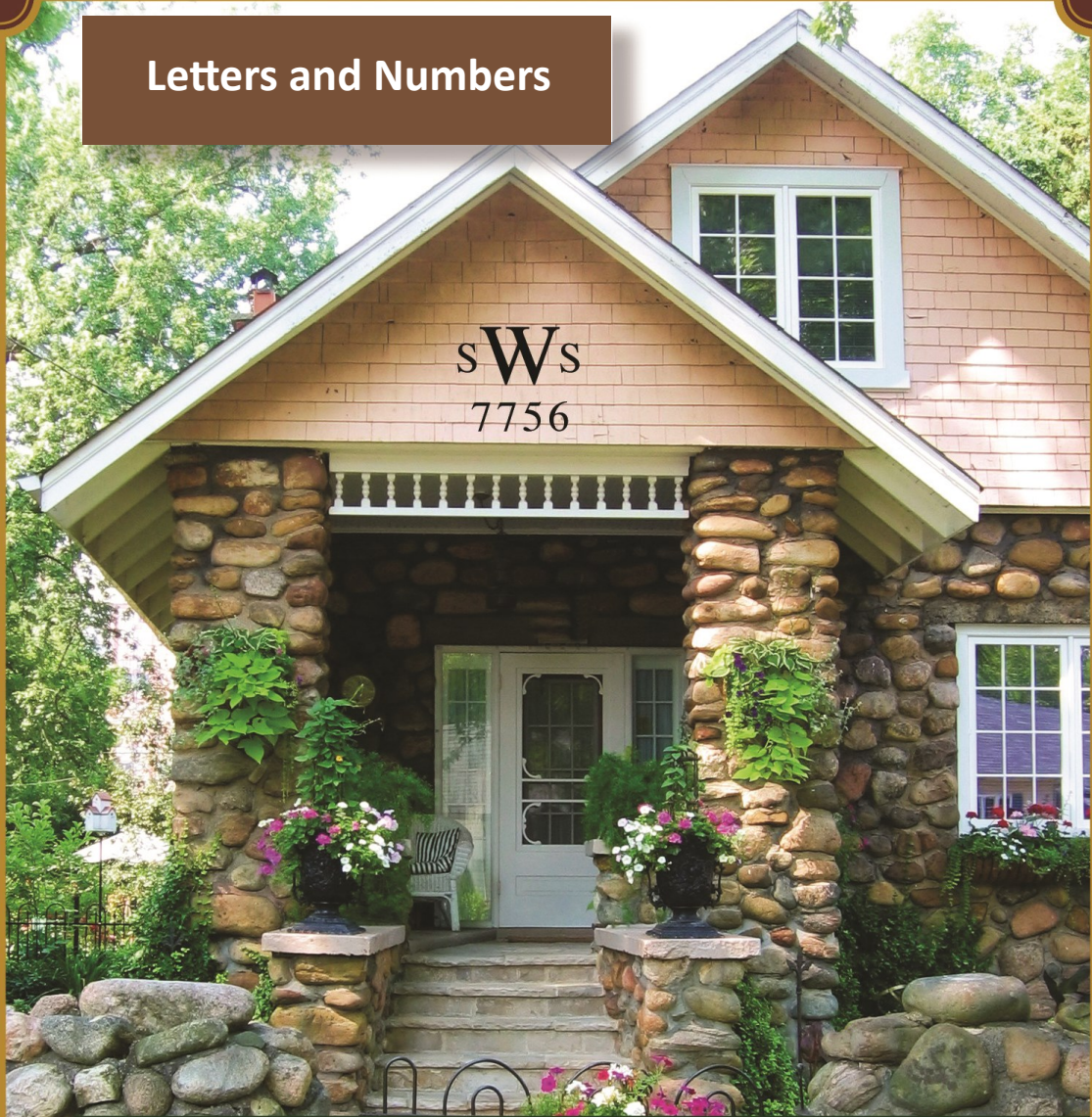

ABC ABC ABC

# HOUSE LETTERS AND NUMBERS

Three Different Sizes For Letters, Two Sizes For Numbers.



ABCDEFG  
HIJKLMN  
OPQRSTU  
VWXYZ &  
  
1234567890

## 6 " Height

Product Codes:

LET- Choose Letter -S

NUM- Choose Number -S

## 12 " Height

Product Codes:

LET- Choose Letter -M

NUM- Choose Number -M

## 18 " Height

Product Codes:

LET- Choose Letter

Numbers NOT Available In 18"



## HOUSE PLAQUES - CUSTOM

Custom House Plaques Are Available  
In The Silhouettes Shown With Up To 13 Characters.  
Each Space Counts As A Character.



# HOUSE PLAQUES - CUSTOM



HP-1



HP-203

Measures 22" W. x 7 1/2" H.

2 - 3 Weeks For Delivery.



HP-6



HP-10



HP-19



HP-20



HP-22



HP-44



HP-68



HP-83



HP-87



HP-105



HP-116



HP-133



HP-139



HP-155



HP-186



# KEY CHAINS

Key Chains Are BLACK Unless Otherwise Shown.



KC-2



KC-6



KC-10



KC-14



KC-19



KC-26



KC-38



KC-39



KC-40



KC-46



KC-51R



KC-53G



KC-56



KC-59



KC-68



KC-70



KC-71



KC-105



KC-111R



KC-134

# KEY HOLDERS... and so much more!

Sizes Range From 7 3/4" W. x 4" H To 7 3/4"W. x 8" H.



KH-151



KH-51





**KEY HOLDERS... and so much more**  
Sizes Range From 7 3/4" W. x 4" H To 7 3/4"W. x 8" H.



KH-1

KH-3

KH-5

KH-6

KH-10



KH-12

KH-14

KH-15

KH-17

KH-18



KH-19

KH-20

KH-22

KH-38

KH-44



KH-45

KH-51

KH-56

KH-68

KH-71

# KEY HOLDERS... and so much more

Sizes Range From 7 3/4" W. x 4" H To 7 3/4"W. x 8" H.



KH-89

KH-93

KH-102

KH-104

KH-105



KH-109

KH-110

KH-116

KH-119

KH-121



KH-129

KH-133

KH-134

KH-139

KH-144



KH-151

KH-155

KH-157

KH-186

KH-249

# KEY HOLDERS - DOGS AND CATS

Sizes Range From 7 ¾" W. x 4" H To 7 ¾"W. x 8" H.



KH-105

KH-236

KH-237

KH-240



KH-241

KH-242

KH-243

KH-244

KH-245



KH-6

KH-246

KH-247

# KEY HOLDERS - SPORTS

Sizes Range From 7 3/4" W. x 4" H To 7 3/4"W. x 8" H.



KH-135

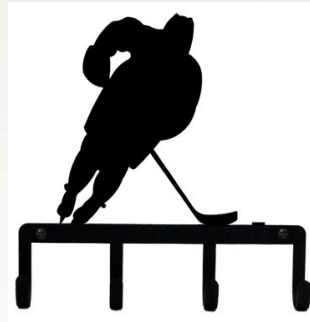

KH-158



KH-179



KH-182



KH-183



KH-191



KH-192



KH-195

# MANTLE HOOKS

Measure Approximately 9" High Including Silhouette.  
Hook To Silhouette Measures 5" High.

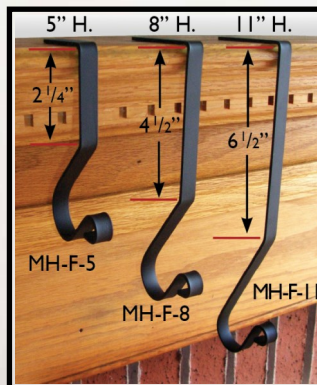
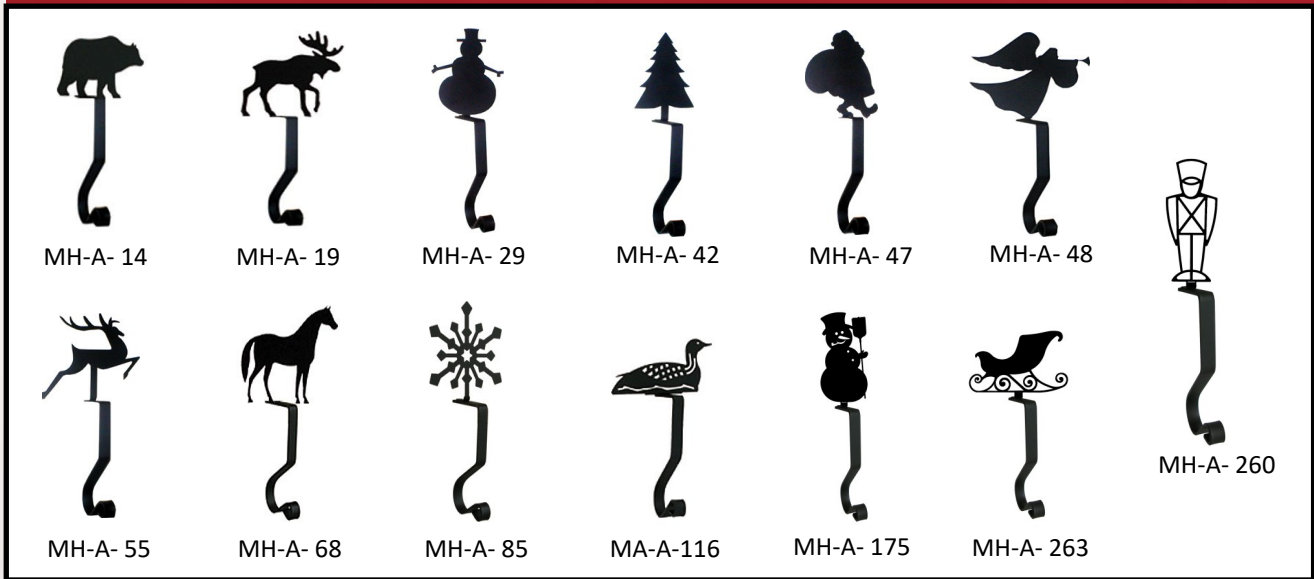

Our Traditional Mantle Hooks  
Are Available in three sizes.

- 5" H    MH-F-5
- 8" H    MH-F-8
- 11" H    MH-F-11

# MITTEN & BOOT DRYING STANDS

Our stands are so sturdy that even ADULT work boots fit!



Mitten/Boot Dryer Stand

12"W. x 39"H.

**Holds 4 Pair**

**of mittens or boots**

**Available in Heart Top ONLY**

Product Code: MD-S-4-51



Mitten/Boot Dryer Stands

12" W. x 39"H. - **Holds 8 Pair**



MD-S-8-50



MD-S-8-150



MD-S-8-85



MD-S-8-51



MD-S-8-175





# NAPKIN HOLDERS

5" W. x 5 1/2" H. x 2 1/4" D.



NH-1



NH-2



NH-3



NH-5



NH-6



NH-10



NH-14



NH-19



# NAPKIN HOLDERS

5" W. x 5 1/2" H. x 2 1/4" D.



NH-18



NH-20



NH-38



NH-44



NH-45

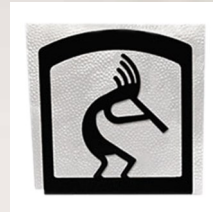

NH-56



NH-66



NH-68



NH-70



NH-71



NH-76



NH-89



NH-91



NH-93



NH-105



NH-109



NH-110



NH-116

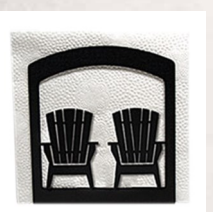

NH-119



NH-133



NH-134



NH-139

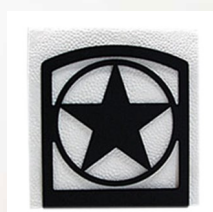

NH-144

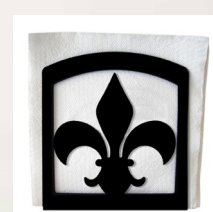

NH-121



NH-155



NH-157



NH-164



NH-186



NH-249



NH-341

# NAPKIN RINGS

Approximate Size 2 ¼" W. x 2 ¼" H. x 1 ¾" D.



NR-1



NR-14



NR-19



NR-38



NR-42



NR-45



NR-46



NR-68



NR-70



NR-71



NR-85



NR-121

# ORGANIZE

It's FUN and it's EASY.

*(Accessories NOT Included.)*



TT-87

\_\_\_" W. x \_\_\_" H. x \_\_\_" D.

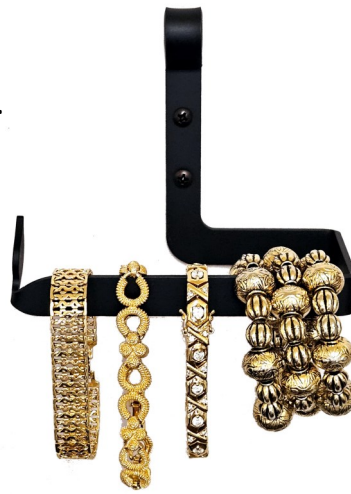

PT-B-87

12" W. x \_\_\_" H. x 4" D.





# PAPER TOWEL HOLDER - WALL MOUNT

Approximately 4" W. x 13 H. x 6" D.



PT-A-1

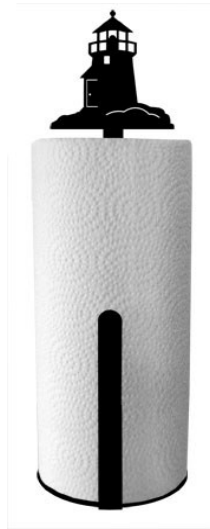

PT-A-10

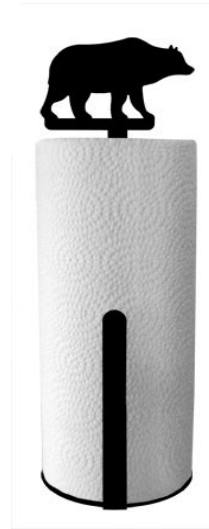

PT-A-14



PT-A-19



PT-A-45

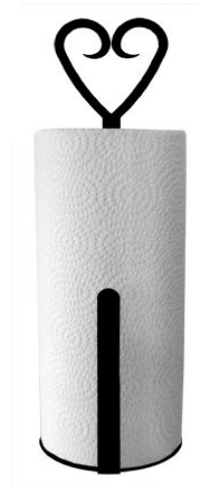

PT-A-51



PT-A-87

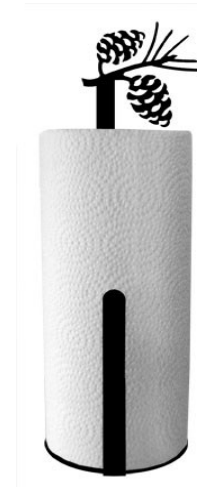

PT-A-89

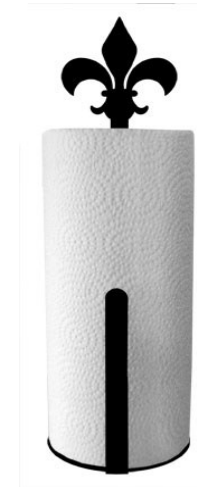

PT-A-121

# PAPER TOWEL HOLDER - WALL MOUNT

Approximate Size 12" W. x 8 1/4" H. x 4" D.

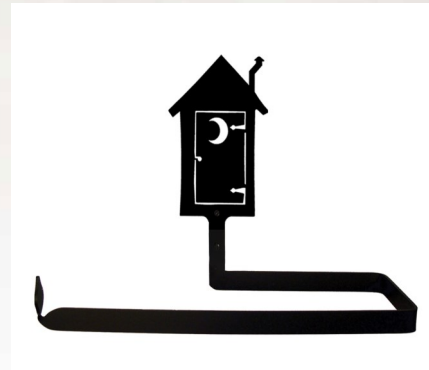

PT-B-256



PT-B-1

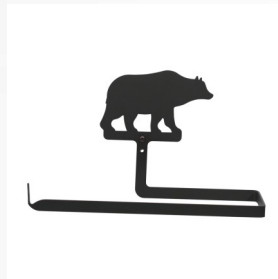

PT-B-14



PT-B-19

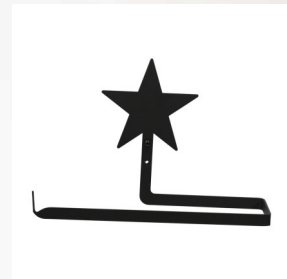

PT-B-45

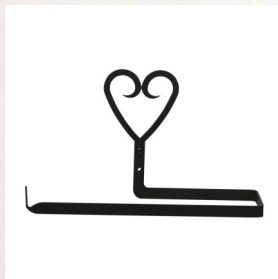

PT-B-51

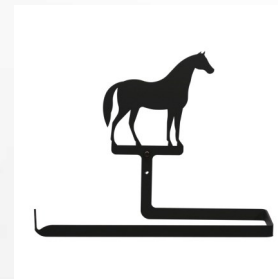

PT-B-68

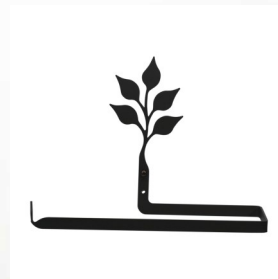

PT-B-76



PT-B-87

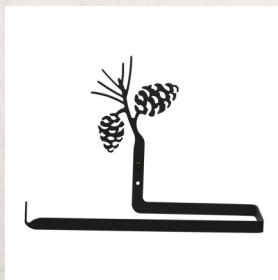

PT-B-89

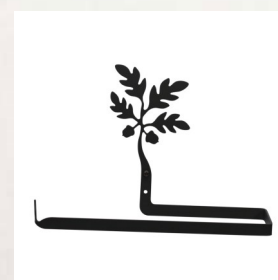

PT-B-93

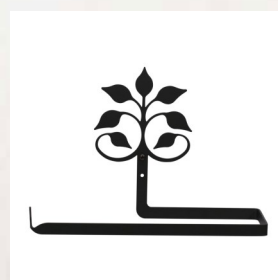

PT-B-109



PT-B-116



# PAPER TOWEL HOLDER - COUNTER TOP

Approximate Size 6" W. x 14" H. x 6" D.

Paper Towel Holders Are Perfect For Your...  
Kitchen - Bathroom - Laundry Room - Work Shop

Product Code: PT-C-\_\_\_



# PAPER TOWEL & RECIPE CARD HOLDER

Hangs on your cabinet handle or knob.



Measures 3" W. x 7" H.

Product Code:

RC-H



PT-C-109



# PLANT HANGERS - FLAT IRON

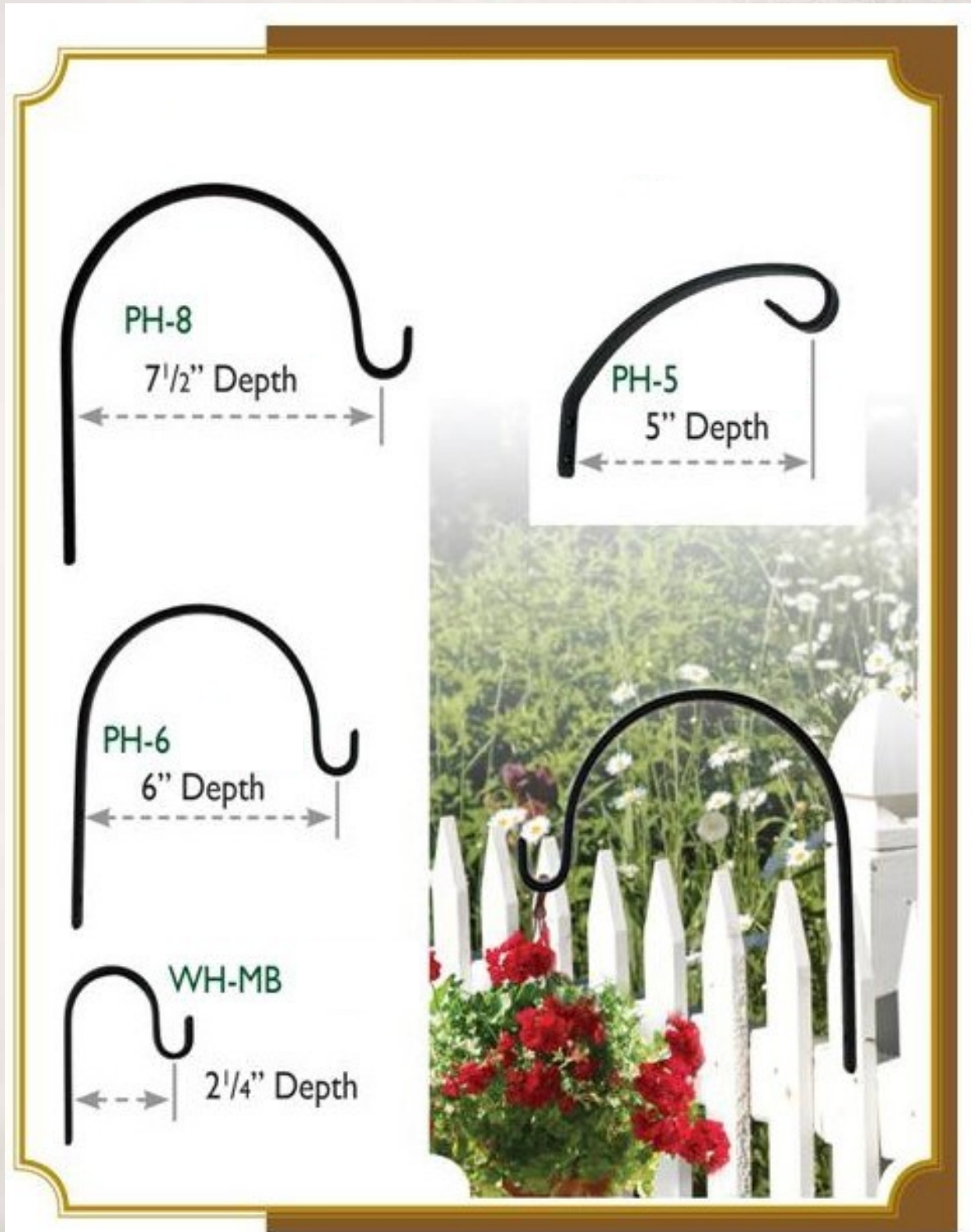

# PLANT HANGERS - REMOVABLE

Round and Square Iron

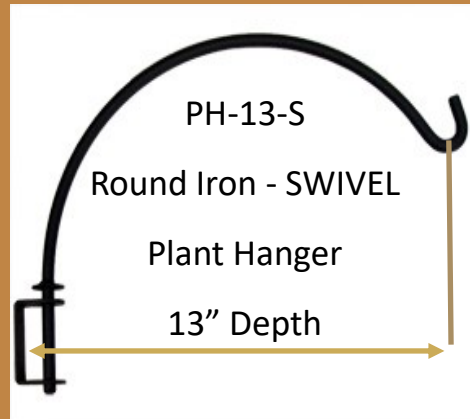

Square Iron:

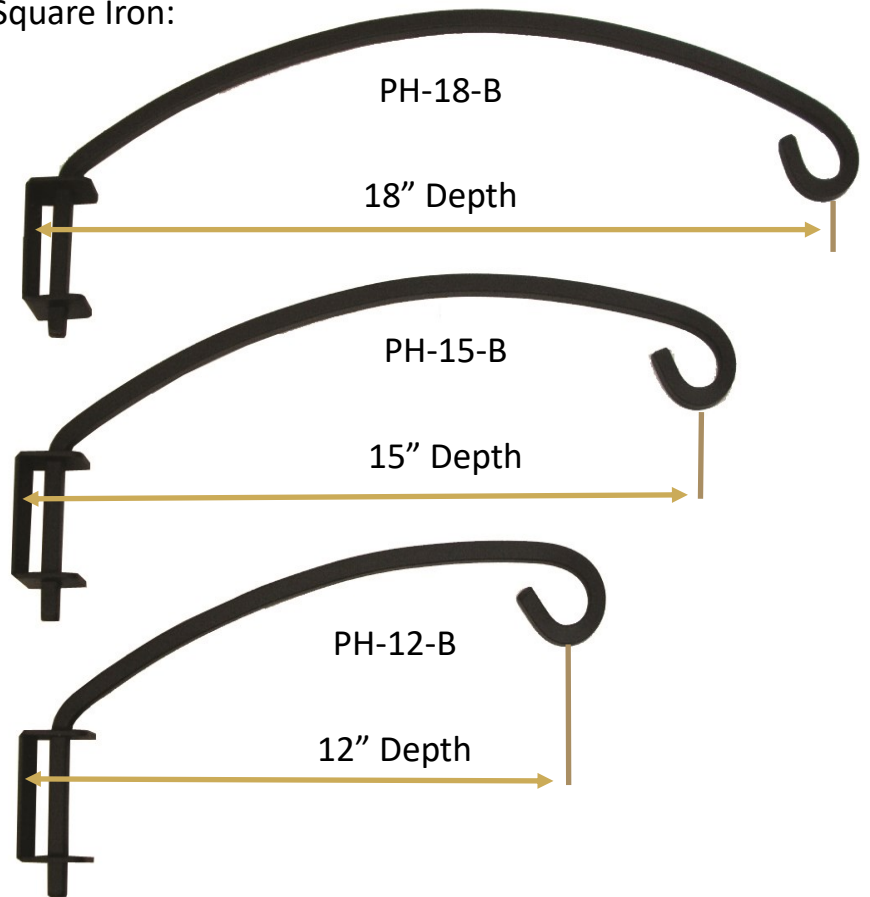



# PLANT HANGERS - SQUARE IRON

10" H x 1 7/8" W. x 12" D.



PHD-22-12



PHD-83-12

# PLAQUES A - Z

24" W. x 11" H. Use Indoors or Outdoors.

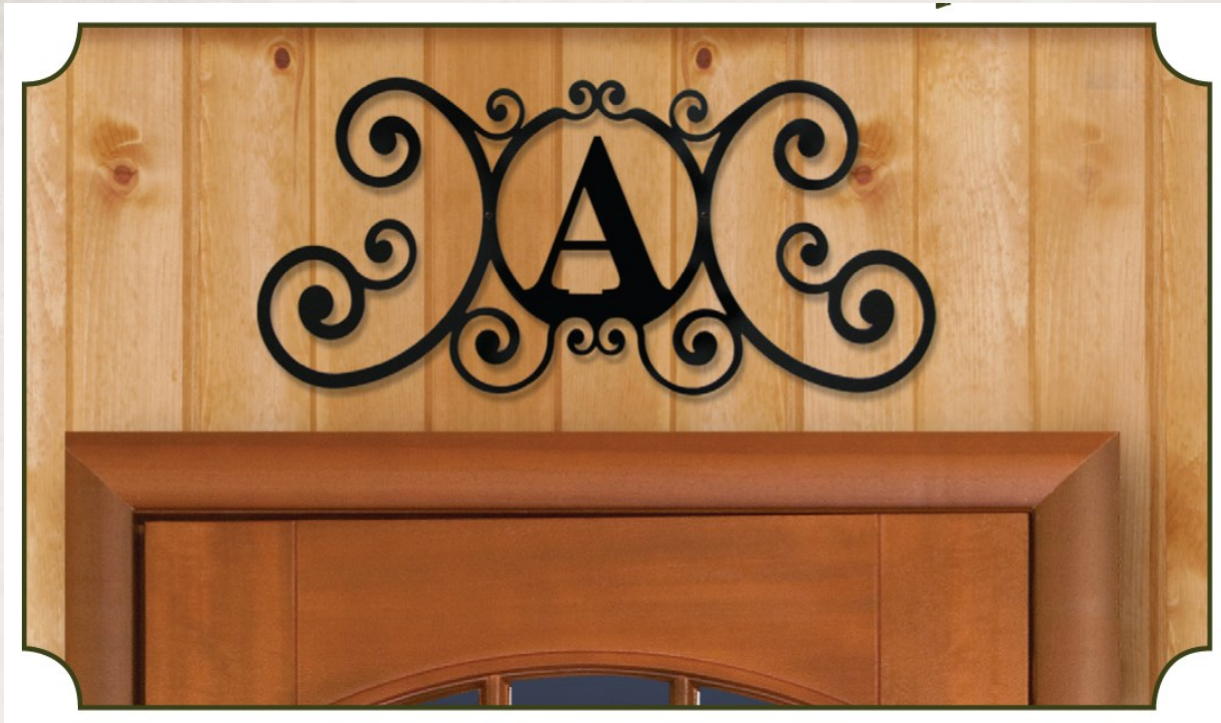

Product Code: HP-OD-\_\_\_\_(Choose Letter)

ABCDEFGHIJKLMNOPQRSTUVWXYZ

**PLAQUES - OUTSIDE OR INSIDE**

24"W x 11" H.



HP-OD-1



HP-OD-3



HP-OD-19



HP-OD-68



HP-OD-105



HP-OD-10



HP-OD-38



HP-OD-71



HP-OD-116



HP-OD-14

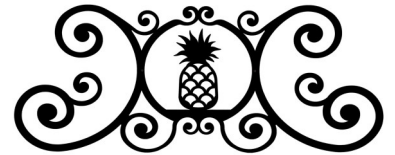

HP-OD-44



HP-OD-45



HP-OD-201

# RECYCLE BINS

Measure 17 1/2" w. x 11" H. x 14 3/4" D.



Attractive and Functional  
*Recycle in style!*



RB-93



RB-87



RB-100-101



RB-109

# S - Hooks

Hang Plants, Dried Herbs & Flowers Even Pots or Pans.

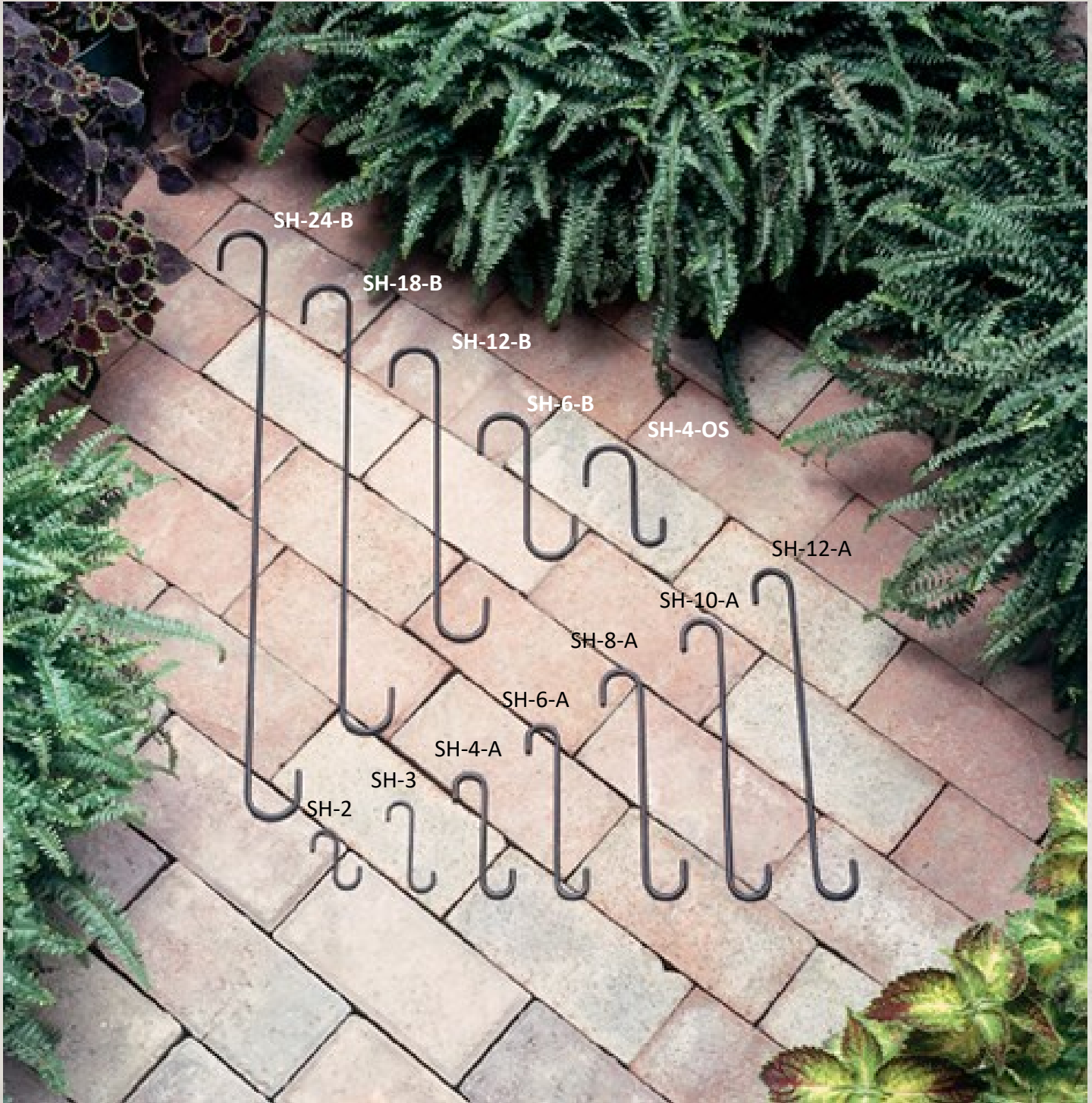

# S - Hooks

Perfect for Hanging ANYTHING.



Product Code	Description
SH-2	2" L. with $\frac{5}{8}$ " Hook Depth
SH-3	3" L. with $\frac{5}{8}$ " Hook Depth
SH-4-A	4" L. with $\frac{3}{4}$ " Hook Depth
SH-4-OS	4" L. with $\frac{3}{4}$ " Hook Depth and 1 $\frac{3}{8}$ " Hook Depth
SH-6-A	6" L. with $\frac{3}{4}$ " W. Hook Depth
SH-6-B	6" L. with 1 $\frac{3}{4}$ " W. Hook Depth
SH-8-A	8" L. with 1" W. Hook Depth
SH-10-A	10" L. with $\frac{3}{4}$ " W. Hook Depth
SH-12-A	12" L. with 1" W. Hook Depth
SH-12-B	12" L. with 1 $\frac{1}{2}$ " W. Hook Depth
SH-18-B	18" L. with 1 $\frac{3}{4}$ " W. Hook Depth
SH-24-B	24" L. with 1 $\frac{1}{2}$ " W. Hook Depth





## S - CHAINS

### S-Chain

*Each S-Chain Hook Measures*

*2 1/2" L. x 5/8" W.*

*Create your own length*

*Sold Individually*

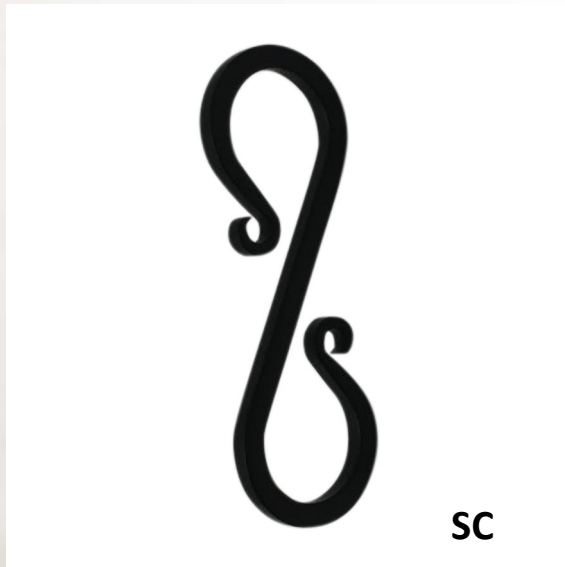

# S - HOOKS - DECORATIVE

Lowering anything to the height you want. 12" High





## **SHELF BRACKETS**

Three Different Sizes

### **Product Code - SB-\_\_-L**

Large Shelf Brackets

Measure 9 1/4" H. x 9 1/4" W.

Holds a 10" Board

### **Product Code - SB-\_\_-M**

Medium Shelf Brackets

Measure 7 1/4" H. 7 1/4" W.

Holds a 8" Board

### **Product Code - SB-\_\_-S**

Medium Shelf Brackets

Measure 5 1/4" H. 5 1/4" W.

Holds a 6" Board

*Sold in Pairs - Wood not included.*

# SHELF BRACKETS

Three Different Sizes

Village  
Wrought  
Iron Inc.

TM

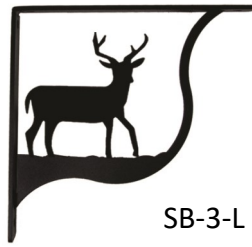

SB-3-L

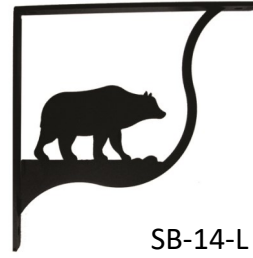

SB-14-L



SB-19-L

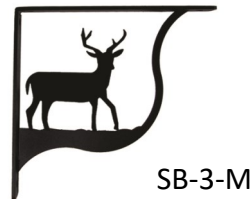

SB-3-M



SB-14-M



SB-19-M



SB-3-S



SB-14-S



SB-19-S



SB-89-L



SB-93-L



SB-109-L

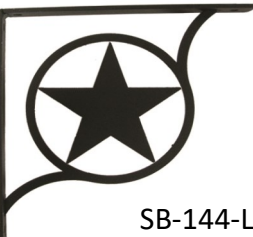

SB-144-L



SB-155-L



SB-89-M



SB-93-M



SB-109-M



SB-144-M



SB-155-M



SB-89-S



SB-93-S



SB-109-S



SB-144-S



SB-155-S



# SELF BRACKETS - EXTRA HEAVY

Measurements 9 1/2" L. x 9 1/2" H. x 1 1/2" W.

## Extra-Heavy Shelf Bracket Pair

Measurements of mounting sides are 9 1/2" L. x 9 1/2" H. x 1 1/2" W.



Two Styles

To

Choose From!

# SELF BRACKETS - EXTRA HEAVY

Measurements 9 1/2" L. x 9 1/2" H. x 1 1/2" W.

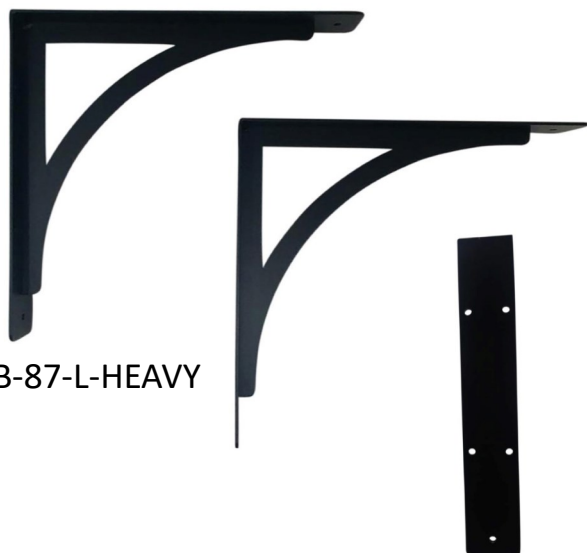

SB-87-L-HEAVY

Backside  
Of Shelf



SB-109-L-HEAVY



**SIGN BRACKETS**  
Available in Three Sizes



# SIGN BRACKETS

Available in Three Sizes



## SGB-103-18

18" L. x 11" H.

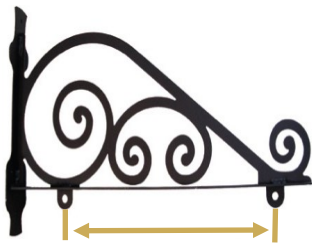

12  $\frac{3}{8}$ "

### SMALL

Sign Bracket

Holes for Hanging  
are  
 $\frac{3}{4}$ " Diam.

## SGB-103-24

24" L. x 14" H.

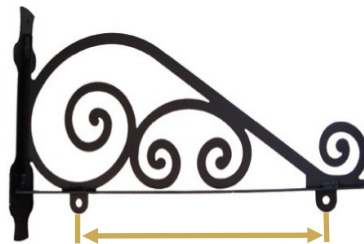

16  $\frac{1}{2}$ "

### MEDIUM

Sign Bracket

Holes for Hanging  
are  
 $\frac{1}{2}$ " Diam.

## SGB-103-36

36" L. x 19" H.



24  $\frac{7}{8}$ "

### LARGE

Sign Bracket

Holes for Hanging  
are  
 $\frac{1}{2}$ " Diam.



**SILHOUETTES - DECORATIVE**

Measure Approximately 12" W. x 17" H.

Product Code: HOS- \_ \_ \_

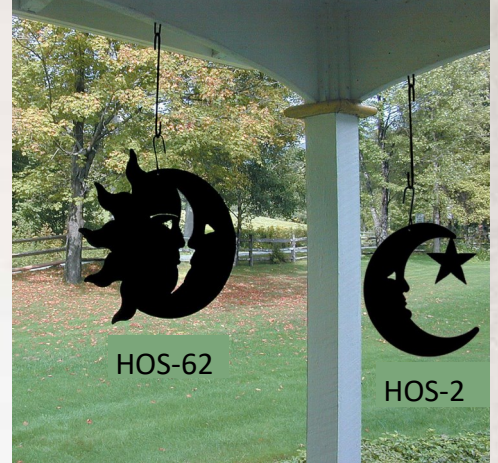
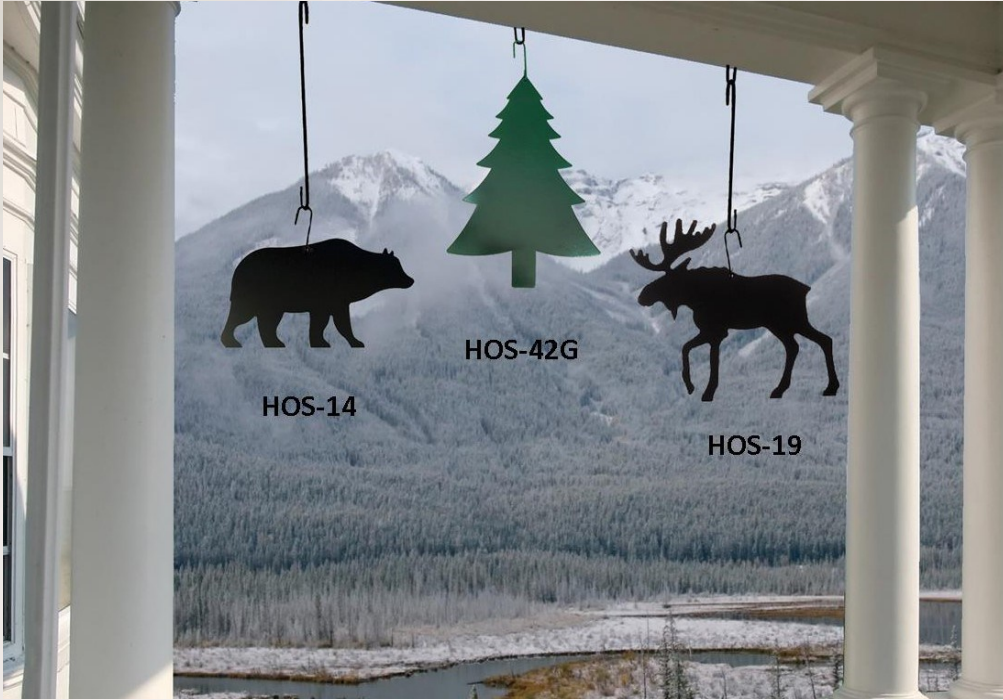

# SILHOUETTES - DECORATIVE

Measure Approximately 12" W. x 17" H.  
Product Code: HOS- \_\_\_\_\_





## SCHOOL FUNDRAISING

Key Chain for your School or Organization.  
Contact Us for More Information.

**SHOW YOUR SCHOOL SPIRIT!**  
Support our school with custom key chains!

**MADE IN U.S.A.**



Each key chain is made of quality domestic wrought iron with a baked on powder coating, for long lasting durability.

*All key chains are manufactured in Central New York by Village Wrought Iron, Inc.*

**ORDER YOUR KEY CHAINS TODAY!** (see reverse side for details)

# SNOW GAUGES

2" and 3" Tall



2' Snow Gauge

4" W.

SG-85-S

3' Snow Gauge

4" W.

SG-85-M

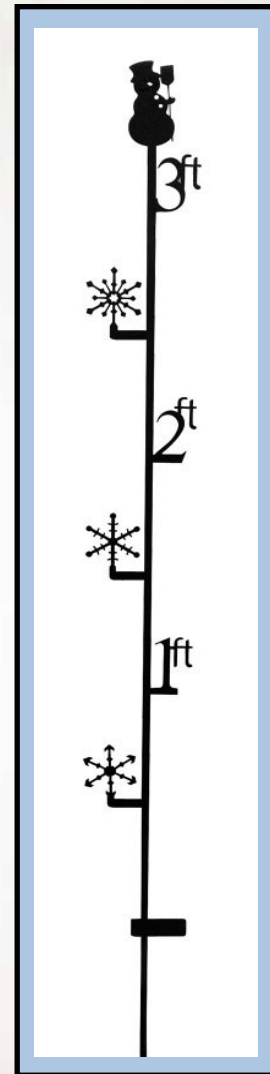

Snowman

3 Foot Snow Gauge

4" W.

SG-175-M

## SPORTS - MEN'S - KEY HOLDERS

Sizes Range From  
7 3/4" W. x 4" H. to 7 3/4" W. x 8" H.



KH-135



KH-151



KH-158



KH-179



KH-182



KH-183



KH-191



KH-192



KH-195

# SPORTS - MEN'S - WALL HOOKS - SM

Measure Approx. 4 1/2" to 5" H.



Measure Approximately

4 1/2" to 5" H.

Hook Depth Measures 1 1/4" D.

Product Code: WH-\_\_\_\_-S

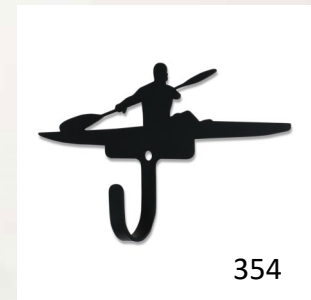
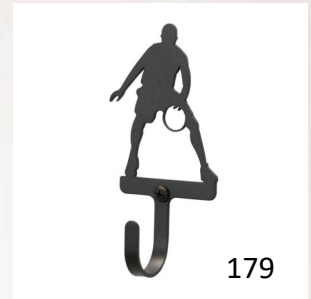



# SPORTS - WOMAN'S - WALL HOOKS - SM





















Product Code: WH-LC-\_\_\_

Measure Approximately

4 1/2" to 5" H.

Hook Depth Measures 1 1/4" D.



 389	 269	 284	 289	 290
 293	 302	 303	 304	 305
 306	 307	 311	 316	 354
 356	 359	 361	 362	 376

# THE OUTHOUSE

Many of our products for your new OUTHOUSE.



Complete List  
Of Switch & Outlet  
Covers  
See Page 26 - 29

ES-256



EG-256



EO-256



ESS-256



EOO-256



ESSS-256



Towel Bar Small

18" W. x 7" H.

TB-256-S



Towel Bar Large

24" W x 7" H.

TB-256-L



Toilet Tissue Holder

5 1/4" W. x 7 7/8" H.

TT-256



Paper Towel Holder

12" W. x 8" H.

PT-B-256



Towel Ring

5 1/2" W. x 12" H.

TBR-256

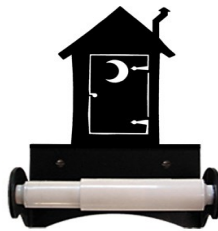

Toilet Tissue Holder w/  
Roll

5 1/4" W. x 7 3/4" H.



Wall Hook Small

2 1/2" W. x 5" H.

WH-256-S



# TOILET TISSUE HOLDERS

TWO DIFFERENT STYLES to choose from.  
*ROLLER STYLE - Roller Included*



TT-B-68



TT-B-116



TT-B-155

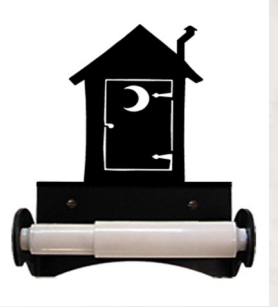

TT-B-256



TT-B-51



TT-B-76



TT-B-87



TT-B-89



TT-B-109

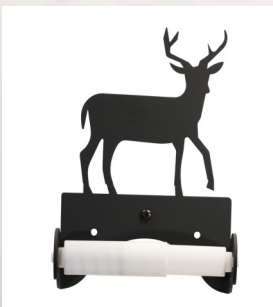

TT-B-3



TT-B-14



TT-B-18



TT-B-19



TT-B-45

# TOILET TISSUE HOLDERS

Holders Range from 6" H. To 10" H.

*TRADITIONAL STYLE*



TT-3

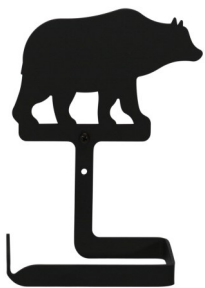

TT-14



TT-18



TT-19



TT-45

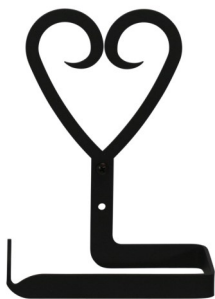

TT-51



TT-68



TT-76



TT-87



TT-89



TT-109



TT-116



TT-155

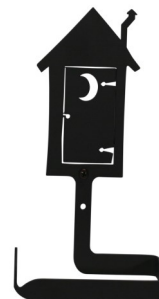

TT-256



# TOWEL BARS

Available in Small and Large.

**SMALL** - Towel Bars

Rod Length 18" L

3" Depth

**LARGE** - Towel Bars

Rod Length 24" L

3" Depth

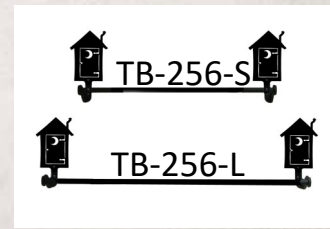
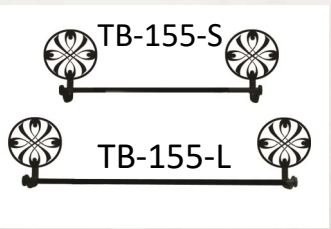
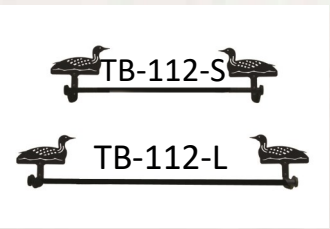
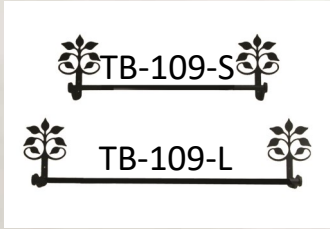
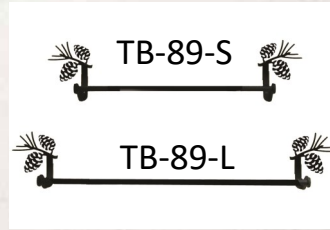
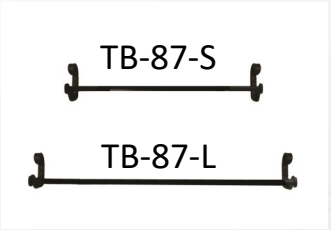
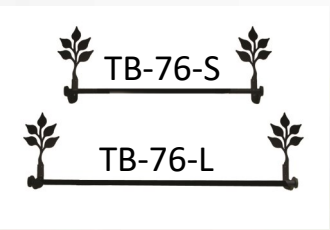
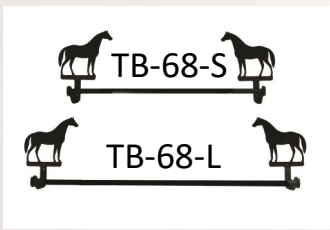
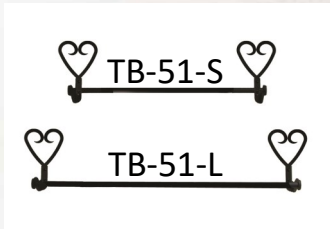
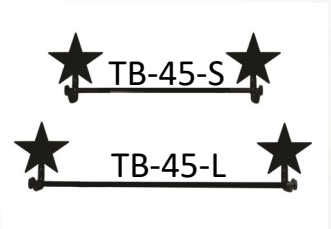
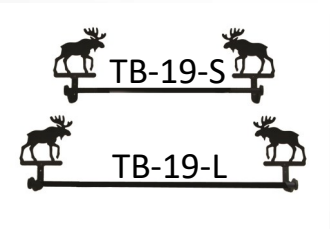
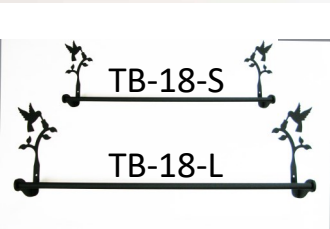
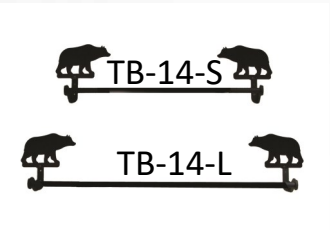
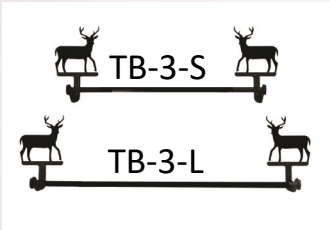

# TOWEL RINGS

For Bath and Hand / Kitchen Towels

Sizes Range from 13 1/2" H. to 18 1/2" H. Towel Ring is 5"



TBR-3



TBR-14



TBR-19



TBR-45



TBR-51



TBR-68



TBR-76



TBR-87



TBR-89



TBR-109



TBR-116



TBR-155



TBR-256



# TRELLISES - NATURAL TO RUSTED TRIPOD

Approximately 58" H.

Our Tripod Trellises start out natural, with no finish and rust over time. Degree of rust may vary at time of shipment. Approximately 58" High.



NTR-50



NTR-127



NTR-PH



**Trellis Plant Hook**  
Add hanging plants to your Tripod Trellises with this tension hook. Sold separately.



# TRIANGLE CHIMES

Available in Small and Large.



*It's  
Time For  
Dinner*



TC-S  
SMALL - Triangle Chime  
8 ½" W. x 10" H.



TC-L  
LARGE - Triangle Chime  
14" W. x 15" H.



# WALL HOOKS - DOUBLE HOOK

Bath Towels, Dish Towels, and even Clothes.

Measure approximately

2 ¼" W. x 2 ¾" H.

Hook Depth Measures ½" D.



WH-D-1

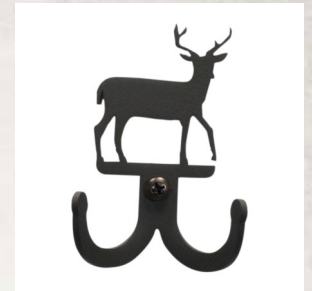

WH-D-3



WH-D-6

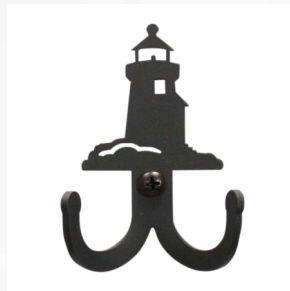

WH-D-10



WH-D-14

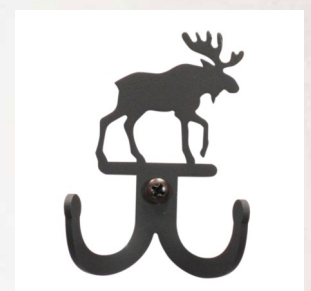

WH-D-19

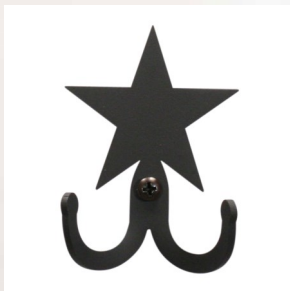

WH-D-45



WH-D-51

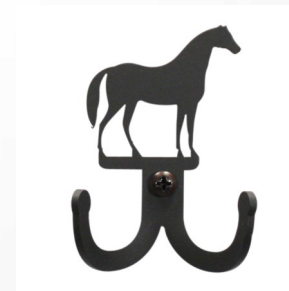

WH-D-68



WH-D-87

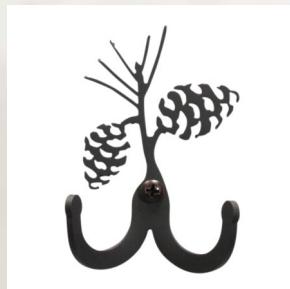

WH-D-89

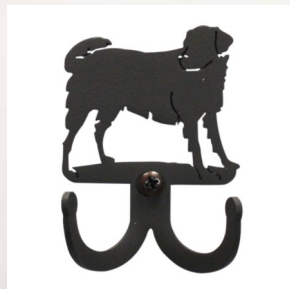

WH-D-105

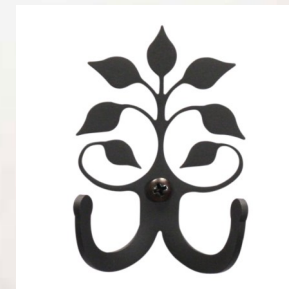

WH-D-109



WH-D-116

# WALL HOOKS - EXTRA SMALL - DECORATIVE



Extra Small Wall Hooks

Measures approximately

2 ¼" H. to 4 ½" H.

Hook Depth Measures ½" D.

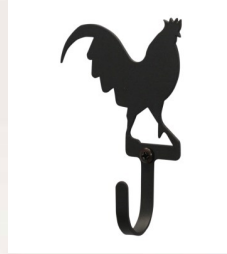

WH-1-XS

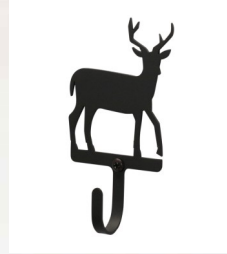

WH-3-XS



WH-6-XS



WH-10-XS



WH-11-XS

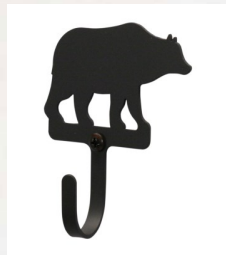

WH-14-XS



WH-18-XS



WH-19-XS

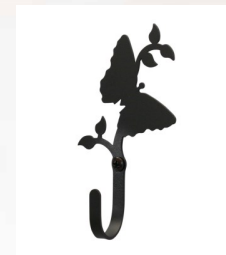

WH-38-XS



WH-39-XS



WH-40-XS



WH-42-XS



WH-45-XS



WH-50-XS



WH-51-XS

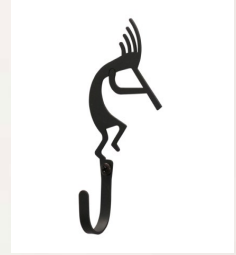

WH-56-XS

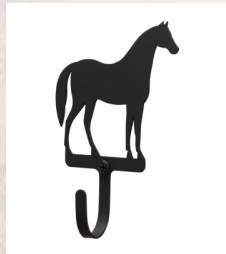

WH-68-XS



WH-70-XS



WH-76-XS



WH-89-XS



WH-93-XS

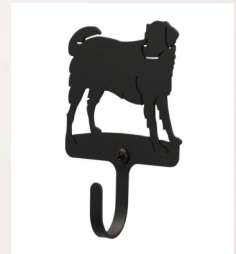

WH-105-XS



WH-109-XS



WH-116-XS



WH-119-XS

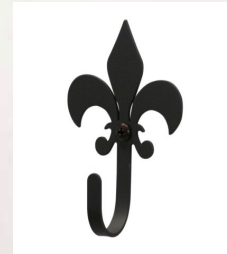

WH-121-XS



WH-173-XS



WH-186-XS





# WALL HOOKS - LARGE

Measure Approximately  
6" to 8 1/2" H.

Hook Depth Measures 1 1/4" D.

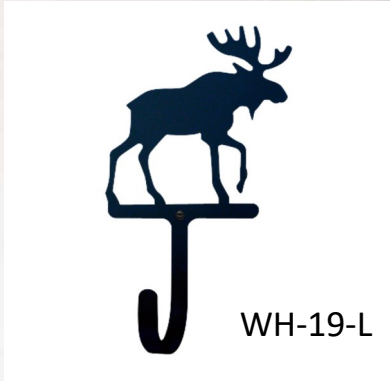

# WALL HOOKS - MISCELLANEOUS

Ceiling - Toggle - Drive In

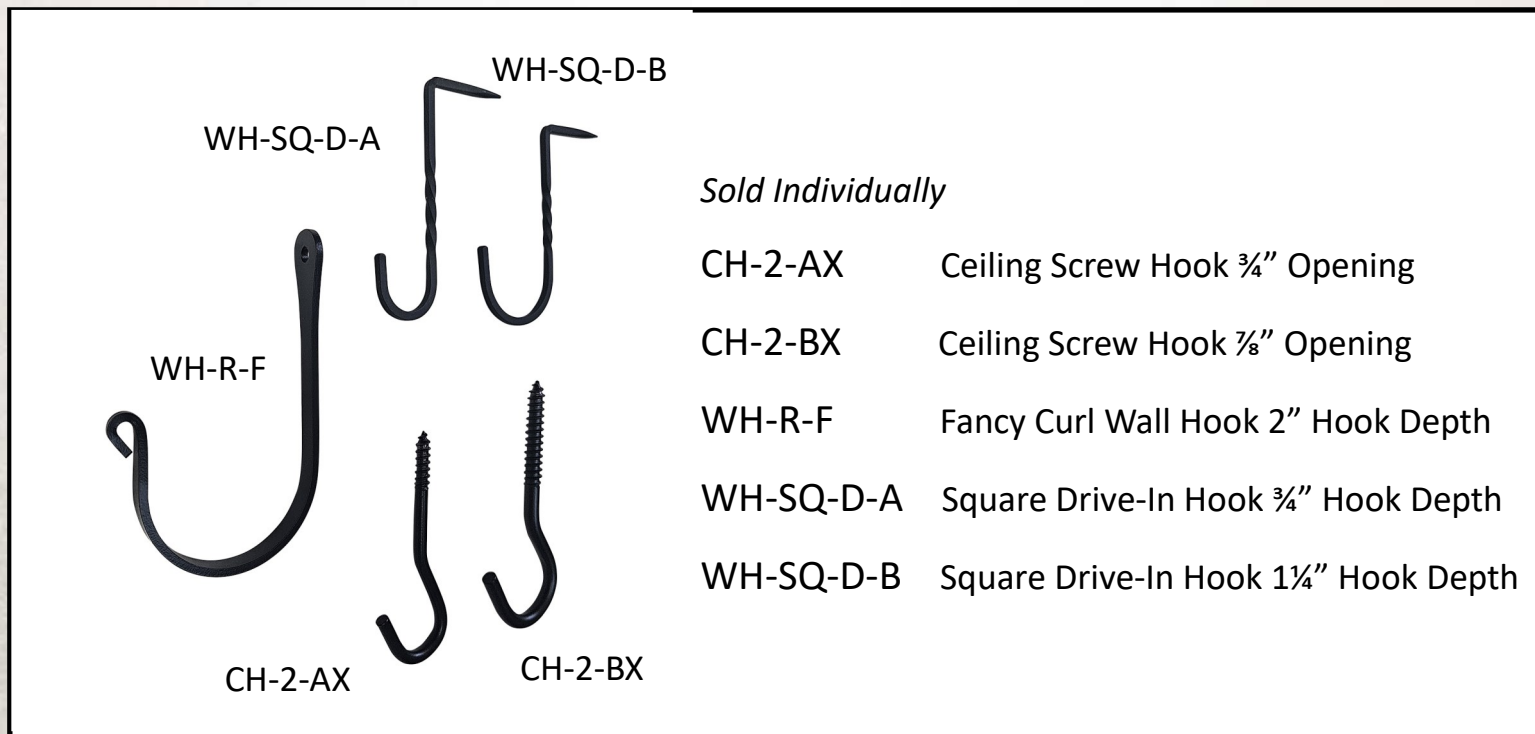
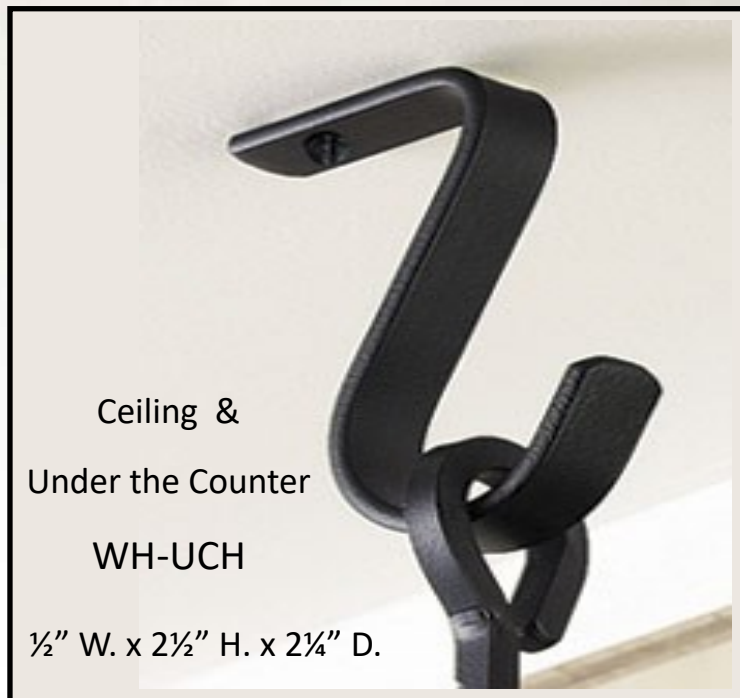
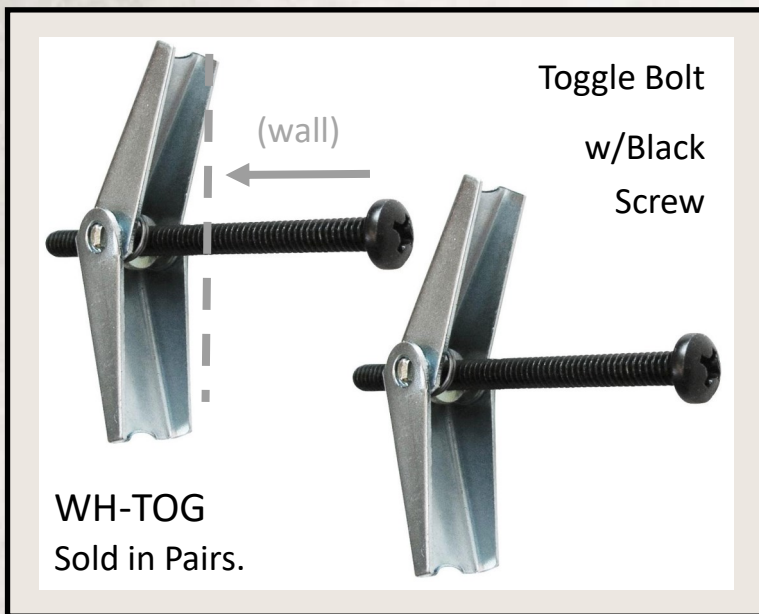

*Sold Individually*

CH-2-AX Ceiling Screw Hook 3/4" Opening

CH-2-BX Ceiling Screw Hook 7/8" Opening

WH-R-F Fancy Curl Wall Hook 2" Hook Depth

WH-SQ-D-A Square Drive-In Hook 3/4" Hook Depth

WH-SQ-D-B Square Drive-In Hook 1 1/4" Hook Depth



# WALL HOOKS - PRIMITIVE

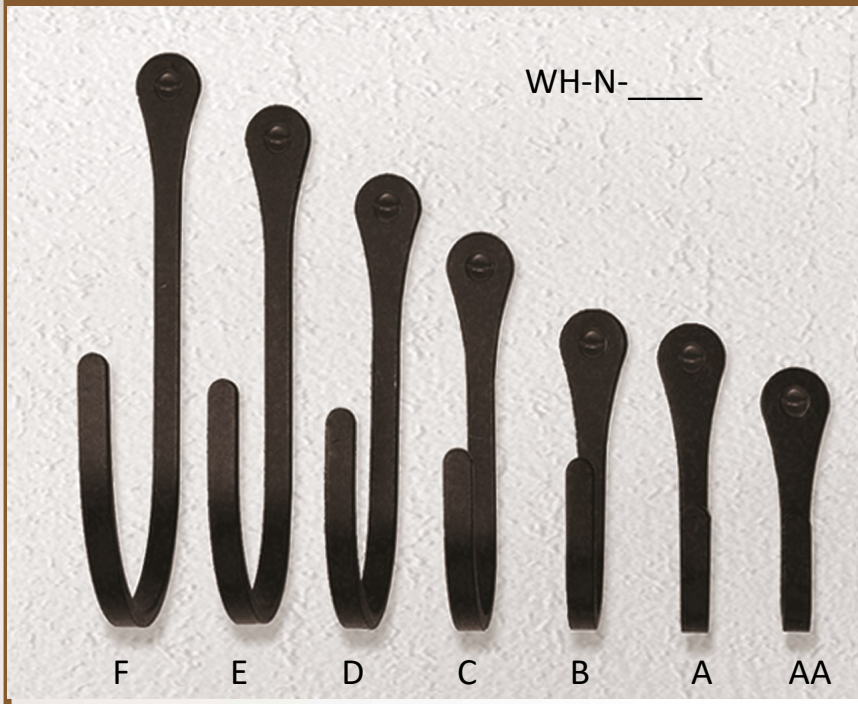

## Narrow Wall Hooks

WH-N-F	2 1/8 Hook Depth
WH-N-E	1 7/8 Hook Depth
WH-N-D	1 9/16 Hook Depth
WH-N-C	1 5/16 Hook Depth
WH-N-B	1 1/8 Hook Depth
WH-N-A	13/16 Hook Depth
WH-N-AA	9/16 Hook Depth

*Sold Individually*

## Wide Wall Hooks

WH-W-H	2 7/8 Hook Depth
WH-W-G	2 7/16 Hook Depth
WH-W-F	2 1/16 Hook Depth
WH-W-E	1 13/16 Hook Depth
WH-W-D	1 1/2 Hook Depth
WH-W-C	1 5/16 Hook Depth
WH-W-B	1 1/16 Hook Depth
WH-W-A	13/16 Hook Depth
WH-W-AA	9/16 Hook Depth

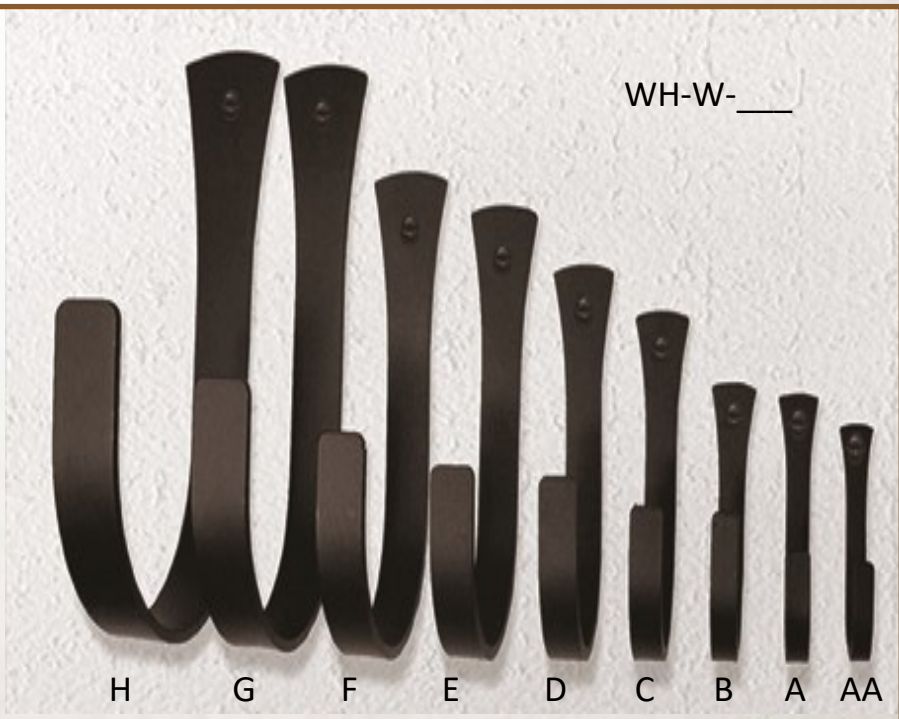

*Sold Individually*

# WALL HOOKS - SMALL - A To Z



Measure Approximately

3 5/8" to 5" H.

Hook Depth Measures 1 1/4" D.

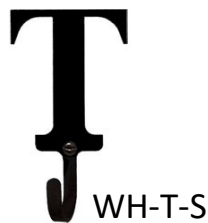



# WALL HOOKS - SMALL - ANIMALS

Product Code: WH-\_\_\_-S

Measure approx. 3 5/8" to 5" H.  
Hook Depth 1 1/4" D.

*Fins, Fur, Feathers & Paws ...*

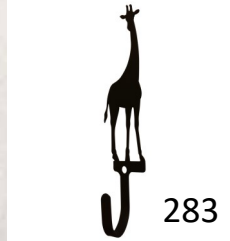
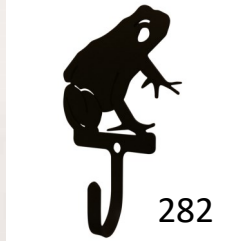
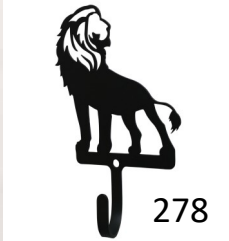
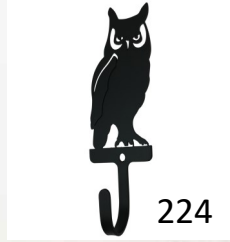
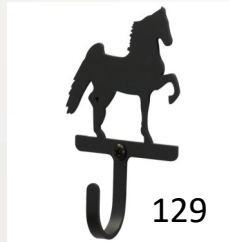
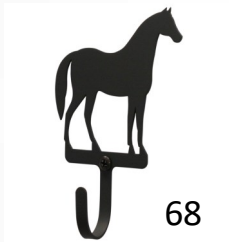
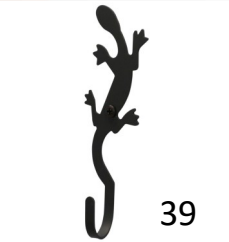
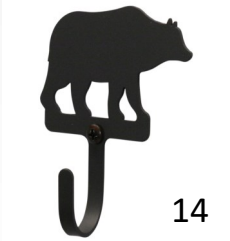

# WALL HOOKS - SMALL - ANIMALS

Product Code: WH-\_\_\_\_-S



Measure approx. 3 5/8" to 5" H.  
Hook Depth 1 1/4" D.

*Antlers and Tusks Too!*

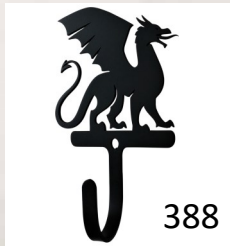
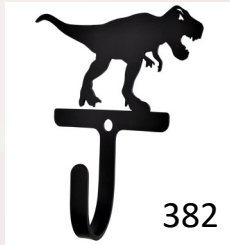



# WALL HOOKS - SMALL CONSTRUCTION EQUIPMENT.

Product Code: WH-\_\_\_-S

Measure Approximately

4 1/2" to 5" H.

Hook Depth Measures 1 1/4" D.

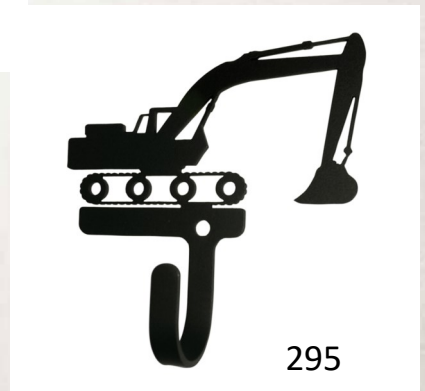
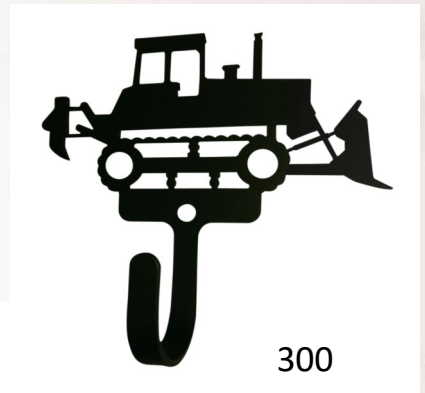

# WALL HOOKS - SMALL DECORATIVE

























Product Code: WH-\_\_\_-S



Measure Approximately

3 5/8" to 5" H.

Hook Depth Measures 1 1/4" D.

 10	 40	 42	 44	 45
 50	 51	 56	 70	 76
 89	 93	 109	 110	 119
 121	 139	 173	 352	 373
 256	 391	 392	 393	 394





# WALL HOOKS - SMALL - MAGNETIC



Measures Approximately  
2 ¼" H. x 4 ½" H. Hook  
Depth Measures ½" D.



WH-MAG-1



WH-MAG-6



WH-MAG-10

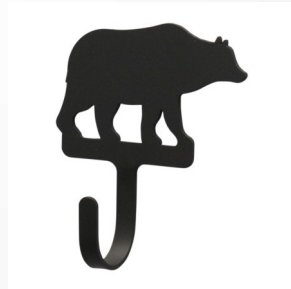

WH-MAG-14



WH-MAG-19



WH-MAG-42



WH-MAG-45

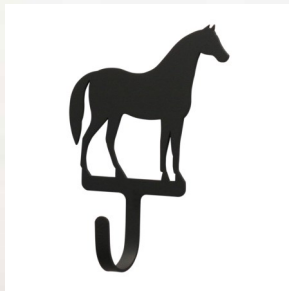

WH-MAG-68

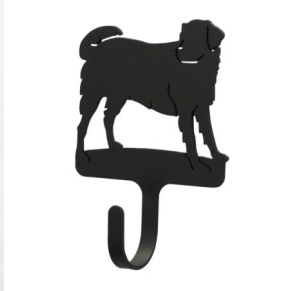

WH-MAG-105



WH-MAG-186

# WALL HOOKS - SMALL - MEN'S

Product Code: WH-\_\_\_-S



Measure Approximately

4 1/2" to 5" H.

Hook Depth Measures 1 1/4" D.

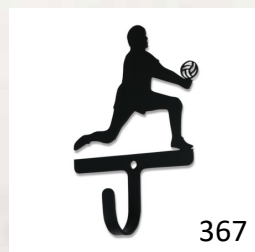
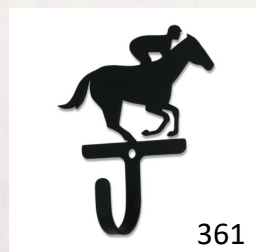
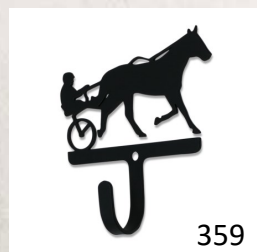
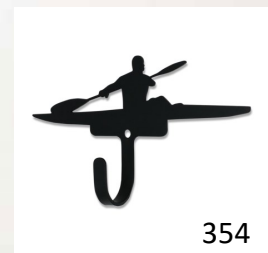
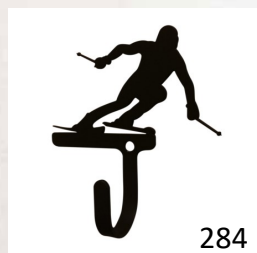
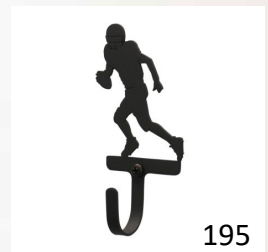
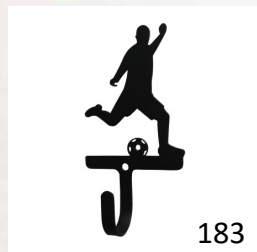
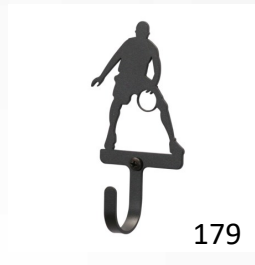



# WALL HOOKS - SMALL RECREATIONAL

Bikes - Motorcycles - Jeep - Snowmobiles - Tractor - Trucks

Measure Approximately

3 5/8" to 5" H.

Hook Depth Measures 1 1/4" D.



WH-286-S



WH-301-S



WH-275-S



WH-312-S



WH-318-S



WH-314-S

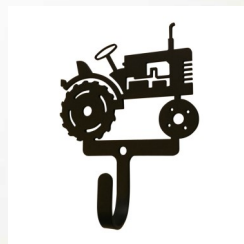

WH-315-S



WH-319-S



WH-323-S



WH-325-S

# WALL HOOKS - SMALL WOMAN'S

Product Code: WH-\_\_\_-S



Measure Approximately

4 1/2" to 5" H.

Hook Depth Measures 1 1/4" D.



**WELCOME SIGNS - LARGE & SMALL**



# WELCOME SIGNS - LARGE & SMALL



## Large Welcome Sign

Measures 17 1/2" W. x 12 1/2" H.

Product Code: WEL-\_\_\_\_-L



## Small Welcome Sign

Measures 11 3/8" W. x 7 7/8" H.

Product Code: WEL-\_\_\_\_-S





# WELCOME SIGNS - MEDIUM

## Medium Welcome Signs

Measures Approximately 12 1/2" W. x 8 1/2" H.



WEL-164



WEL-176



WEL-177



WEL-178



WEL-185



WEL-188



WEL-190



WEL-193



WEL-232

**WELCOME SIGNS - MEDIUM**





**WINE & GLASS CADDY**

2 Glass and Wine Caddy

WRC-C-89



6 1/2" W. x 9" H. x 8" D.  
Holds 1 bottle & 2 wine glasses.

WRC-C-22



WRC-C-121



Wine Bottle And Glasses

WRC-C-157



# WINE & GLASS CADDY

4 Glass and Wine Caddy



9 1/2" W. x 9 1/4" H. x 6 1/2" D.

Holds 1 Bottle & 4 Wine Glasses.



Wine Bottle And Glasses  
Are NOT Included.



WRC-B-157



WRC-B-121



# WINE RACKS

Small - Medium - Large



WR-76-S  
Small  
Leaf Wine Rack



WR-157-S  
Small  
Grapevine Wine Rack



WR-157-M  
Medium  
Grapevine Wine Rack



WR-76-M  
Medium Leaf Wine Rack



WR-76-L  
Large Leaf Wine Rack

# WINE RACKS

Small - Medium - Large



*Cheers - Let's Celebrate*

## Wine Racks

### Small

- WR-76-S Leaf Wine Rack Holds 3 Bottles  
9" W. x 9½" H. x 7" D.
- WR-157-S Grapevine Wine Rack Holds 3 Bottles  
9" W. x 9½" H. x 7" D.

### Medium

- WR-76-M Leaf Wine Rack Holds 6 Bottles  
14½" W. x 9¼" H. x 7" D.
- WR-157-M Grapevine Wine Rack Holds 5 Bottles  
9" W. x 13½" H. x 7" D.

### Large

- WR-76-L Leaf Wine Rack Holds 10 Bottles  
14½" W. x 13¼" H. x 7" D.



*Wine Bottles are NOT included.*

# WINE RACKS - WALL MOUNT

Grapevine Style



WR-WM-157-XXS



WR-WM-157-XS



WR-WM-157-XXS

Holds 1 Wine Bottle & 2 Glasses

7 ¾" W. x 8 ¼" H. x 3 ¾" D.



WR-WM-157-XS

Holds 2 Wine Bottles & 4 Glasses

15" W. x 13 ⅛" H. x 4 ¼" D.

# WINE RACKS - WALL MOUNT

Grapevine Style

Village  
Wrought  
Iron Inc.

TM



WR-WM-157-S



WR-WM-157-M



WR-WM-157-S

Holds 3 Wine Bottles & 2 Glasses

7 ¾" W. x 15 ½" H. x 5 ¾" D.



WR-WM-157-M

Holds 5 Wine Bottles & 4 Glasses

8 ¼" W. x 16 ½" H. x 9" D.



# WOOD RACKS



## Fireplace Wood Racks

16" W. x 17 1/2" H. x 18" D.



FP-WR-89

Pine Cone Wood Rack



FP-WR-22-83

Moose and Bear Wood Rack

Moose is featured on one side,  
Bear on the other side.



**WREATH HANGERS**

13" Long

Wreath  
Hangers

Measure 13" L.

Hangs flat on door.



WRE-B-45



# WREATH HANGERS

13" Long



WRE-A



WRE-A-W



WRE-B-14



WRE-B-19



WRE-B-48



WRE-B-85



WRE-B-110

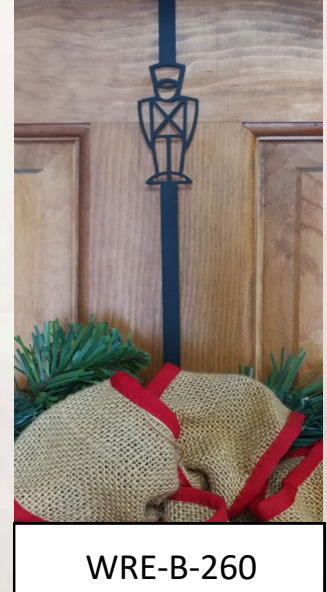

WRE-B-260

